

MENSHEN Weltweit
MENSHEN Worldwide

MENSHEN – SUSTAINABLE INNOVATIVE PACKAGING.



Unternehmensgeschichte

Tradition und Fortschritt werden bei MENSHEN seit über fünf Jahrzehnten groß geschrieben. Das inhabergeführte Unternehmen wurde im Jahr 1970 im sauerländischen Finnentrop gegründet und verfügt heute über insgesamt vierzehn Standorte in elf Ländern. Bereits zwei Jahre nach dem Firmenstart wurde mit Waldwick Plastics ein Standort in den USA gegründet. 1992 folgte die Eröffnung von MENSHEN Emballages in Frankreich. In den Folgejahren erweiterte sich die Unternehmensgruppe mit Produktions- und Vertriebsstandorten in Spanien, Mexiko, China, Singapur, Ungarn, der Schweiz und in Russland.

Heute gehört MENSHEN zu den weltweit führenden Herstellern von Kunststoffverschlüssen und Systemverpackungen und beschäftigt rund 1.400 Mitarbeiter*innen auf der ganzen Welt.

Company History

Tradition and progress have typified MENSHEN for more than five decades. The owner-operated company was formed in 1970 in the city of Finnentrop in the Sauerland region and now has a total of 13 locations across eleven countries. A site was created in the USA within two years of the company's foundation in the form of Waldwick Plastics. The year 1992 saw the opening of MENSHEN UK Ltd. in the United Kingdom, and in 1992 came MENSHEN Emballage in France. Over the following years, the company expanded with production and sales sites in Spain, Mexico, China, Singapore, Hungary, Switzerland and Russia.

Today, MENSHEN is one of the world's leading manufacturers of plastic closures and system packaging and employs around 1,400 people around the world.



Philosophie

MENSHEN steht für Kompetenz, Individualität, Engagement und Nachhaltigkeit. Unserer weltweiten Verantwortung sind wir uns stets bewusst. Deshalb ist kundenorientiertes Denken und Handeln unser ständiger Antrieb. Ob individuelle Verschlusslösungen, komplexe Aufgabenstellungen oder höchste Sicherheitsansprüche – MENSHEN bietet seinen Kunden eine Zusammenarbeit ohne Kompromisse und Qualität ohne Abstriche.

Wir bei MENSHEN wissen: Die Zukunft bietet viele Möglichkeiten. Unser Anspruch ist es deshalb, uns stets weiterzuentwickeln und dynamisch auf die Anforderungen im Markt zu reagieren. Denn wer langfristig Maßstäbe setzen möchte, muss einen Schritt voraus sein. Dieses Ziel werden wir auch in Zukunft konsequent verfolgen, um unseren Kunden ein Höchstmaß an Vielseitigkeit und Fortschritt zu gewährleisten.

Philosophy

MENSHEN is renowned for expertise, individuality, dedication, and sustainability. We are constantly aware of our global responsibility. As a result, we are constantly motivated by customer-oriented thinking and actions. Be it individual closure solutions, complex tasks, or the highest safety standards, MENSHEN offers its customers collaboration and quality without compromise.

At MENSHEN, we know that the future brings many opportunities. It is therefore our mission continually to develop and respond dynamically to market requirements. In order to set new standards over the long term, it is necessary to be a step ahead of the industry. We will continue to strive toward this goal consistently in the future, so that we can ensure our customers a high level of versatility and technological progress.

VERSCHLÜSSE FÜR TUBEN // TUBE CLOSURES

| | | |
|----------|--|----|
| 1 | Verschlüsse und Schwammaufträger für Flaschen und Tuben <i>Closing and Sponge Applications for Bottles and Tubes</i> | |
| 1.1 | FLASCHENVERSCHLÜSSE // CLOSURES FOR BOTTLES | |
| 1.1.1 | DOSIER-SCHRAUBVERSCHLÜSSE // DOSAGE SCREW CAPS | 10 |
| 1.1.2 | PUSH-PULL-VERSCHLÜSSE // PUSH-PULL CAPS | 16 |
| 1.1.3 | SCHRAUBVERSCHLÜSSE // SCREW CAPS | 17 |
| 1.1.4 | KLAPPSCHARNIER-SCHRAUBVERSCHLÜSSE // FLIP-TOP SCREW CAPS | 23 |
| 1.1.5 | KLAPPSCHARNIER-PRELLVERSCHLÜSSE // FLIP-TOP PUSH ON CAPS | 26 |
| 1.1.6 | KIPPHEBEL-SCHRAUBVERSCHLÜSSE // TURRET SCREW CAPS | 29 |
| 1.1.7 | VERSCHLÜSSE FÜR TUBEN // TUBE CLOSURES | 30 |
| 1.1.8 | SCHWAMMAUFTRÄGER FÜR PASTÖSE FÜLLGÜTER // SPONGE APPLICATORS FOR VISCOUS FILLINGS | 32 |
| 1.1.9 | SCHWAMMAUFTRÄGER FÜR FLÜSSIGE FÜLLGÜTER // SPONGE APPLICATORS FOR LIQUID FILLINGS | 34 |
| | TECHNISCHE EIGENSCHAFTEN DER SCHWÄMME „PUR“ // TECHNICAL CHARACTERISTICS OF “PUR” MENSHEN SPONGES | 36 |
| 1.1.10 | KOMPLETTVERPACKUNGEN // COMPLETE PACKAGING | 37 |
| 1.1.11 | SONSTIGE VERPACKUNGEN // OTHER PACKAGING | 38 |
| 2 | Weldspouts für flexible Verpackungen <i>Weldspouts for Flexible Packaging</i> | |
| 2.1. | FÜLLUNG DURCH BEUTEL // FILLING THROUGH POUCH | 42 |
| 2.2. | FÜLLUNG DURCH WELDSPORT // FILLING THROUGH WELDSPORT | 47 |
| 2.3. | FÜLLUNG DURCH BEUTEL UND DURCH WELDSPORT // FILLING THROUGH POUCH AND WELDSPORT | 49 |
| 3 | Chemieverschlüsse <i>Chemical Closures</i> | |
| 3. | CHEMIEVERSCHLÜSSE // CHEMICAL CLOSURES | 56 |
| 4 | KAPSEL-LÖSUNGEN <i>CAPSULE SOLUTIONS</i> | |
| 4. | KAPSEL-LÖSUNGEN // CAPSULE SOLUTIONS | 66 |
| 5 | TIEGEL UND DISPENSER <i>DECORATED JARS AND DISPENSERS</i> | |
| 5. | TIEGEL UND DISPENSER // DECORATED JARS AND DISPENSERS | 68 |

Unser Ziel für die Zukunft –

25% Rezyklat-Anteil in unserer Produktion

Our ambition for the future –

25% recyclates share in our production

▼
MENSHEN – SUSTAINABLE INNOVATIVE PACKAGING.





1

Verschlüsse und Schwammaufträger für Flaschen und Tuben *Closures and sponge applicators for bottles and tubes*

Überzeugende Designs, optimale Funktionalität, individuelle Lösungen – MENSHEN eröffnet eine Produktwelt, in der die Bedürfnisse der Kunden immer im Fokus stehen. Lassen Sie sich von der langjährigen Erfahrung und dem umfassenden Know-how unserer Mitarbeiter*innen überzeugen. MENSHEN bietet Ihnen ein vielfältiges Produktsortiment von bester Qualität im Bereich Verschlüsse und Schwammaufträger für Flaschen und Tuben.

Compelling designs, optimal functionality, and individual solutions – MENSHEN opens up a world of products where customer requirements always come first. Take advantage of the years of experience and comprehensive expertise of our employees. MENSHEN offers you an extensive range of closures and sponge applicators for bottles and tubes in the highest quality.

Optimale Lösungen für sauberes und einfaches Dosieren bieten die hochwertigen Dosier-Schraubverschlüsse. Durch ihre präzise Funktionalität eignen sie sich bestens für die Reinigungs- und Waschmittelindustrie.

The high-quality dosage screw closures provide optimal solutions for clean and simple dosage. They are ideally suited to the detergents industry thanks to their precise functionality.



Artikel links/Article left (33212..2) Seite 13/Page 13
Artikel rechts/Article right (33216..1) Seite 15/Page 15

DOSIER-SCHRAUBVERSCHLÜSSE // DOSAGE SCREW CAPS

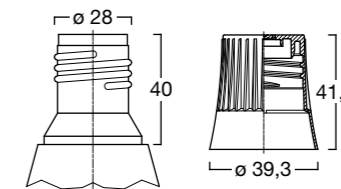

| Artikel-Nr. article no. | Material material | Anbringungsart fixing type | Gewindegröße thread size | Dosiervolumen dosage volume | Dichtung seal | Originalitätsverschluss tamper evidence | Kindersicherung child resistance | Entgasung venting device |
|----------------------------|----------------------|---------------------------------|-----------------------------|--------------------------------|------------------|--|-------------------------------------|-----------------------------|
| 22009..1 | PP | Schraubversion screw version | 28 mm | - | Konus cone | - | - | ■ |

DOSIER-SCHRAUBVERSCHLÜSSE // DOSAGE SCREW CAPS

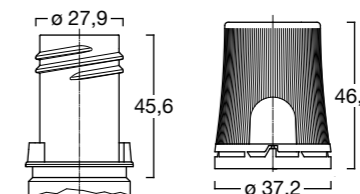

| Artikel-Nr. article no. | Material material | Anbringungsart fixing type | Gewindegröße thread size | Dosiervolumen dosage volume | Dichtung seal | Originalitätsverschluss tamper evidence | Kindersicherung child resistance | Entgasung venting device |
|----------------------------|----------------------|---------------------------------|-----------------------------|--------------------------------|------------------|--|-------------------------------------|-----------------------------|
| 52099..1 | PE | Schraubversion screw version | 28 mm | 25 ml | Konus cone | ■ | ■ | - |

DOSIER-SCHRAUBVERSCHLÜSSE // DOSAGE SCREW CAPS

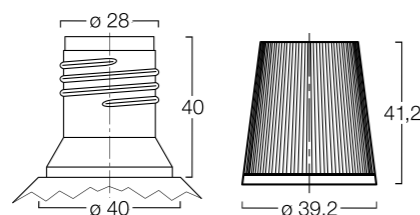

| Artikel-Nr. article no. | Material material | Anbringungsart fixing type | Gewindegröße thread size | Dosiervolumen dosage volume | Dichtung seal | Originalitätsverschluss tamper evidence | Kindersicherung child resistance | Entgasung venting device |
|----------------------------|----------------------|---------------------------------|-----------------------------|--------------------------------|------------------|--|-------------------------------------|-----------------------------|
| 11270..1 | PP | Schraubversion screw version | 28 mm | 30 ml | Konus cone | - | - | - |

DOSIER-SCHRAUBVERSCHLÜSSE // DOSAGE SCREW CAPS

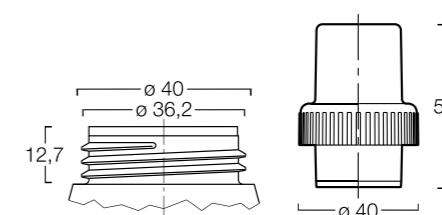

| Artikel-Nr. article no. | Material material | Anbringungsart fixing type | Gewindegröße thread size | Dosiervolumen dosage volume | Dichtung seal | Originalitätsverschluss tamper evidence | Kindersicherung child resistance | Entgasung venting device |
|----------------------------|----------------------|---------------------------------|-----------------------------|--------------------------------|------------------|--|-------------------------------------|-----------------------------|
| 12004..1 | PP | Schraubversion screw version | 36 mm | 30 ml | Konus cone | - | - | - |

DOSIER-SCHRAUBVERSCHLÜSSE // DOSAGE SCREW CAPS

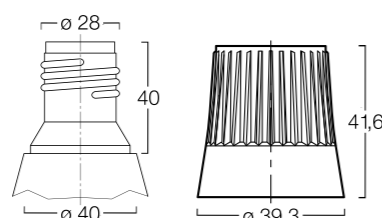

| Artikel-Nr. article no. | Material material | Anbringungsart fixing type | Gewindegröße thread size | Dosiervolumen dosage volume | Dichtung seal | Originalitätsverschluss tamper evidence | Kindersicherung child resistance | Entgasung venting device |
|----------------------------|----------------------|---------------------------------|-----------------------------|--------------------------------|------------------|--|-------------------------------------|-----------------------------|
| 12664..1 | PP | Schraubversion screw version | 28 mm | 30 ml | Konus cone | - | - | - |

DOSIER-SCHRAUBVERSCHLÜSSE // DOSAGE SCREW CAPS

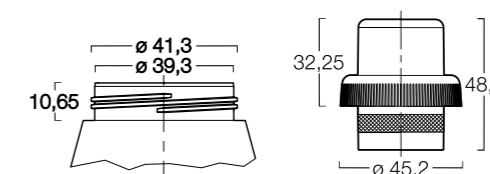

| Artikel-Nr. article no. | Material material | Anbringungsart fixing type | Gewindegröße thread size | Dosiervolumen dosage volume | Dichtung seal | Originalitätsverschluss tamper evidence | Kindersicherung child resistance | Entgasung venting device |
|----------------------------|----------------------|---------------------------------|-----------------------------|--------------------------------|------------------|--|-------------------------------------|-----------------------------|
| 12957..1 | PP | Schraubversion screw version | 42 mm | 30 ml | Konus cone | - | - | - |

DOSIER-SCHRAUBVERSCHLÜSSE // DOSAGE SCREW CAPS

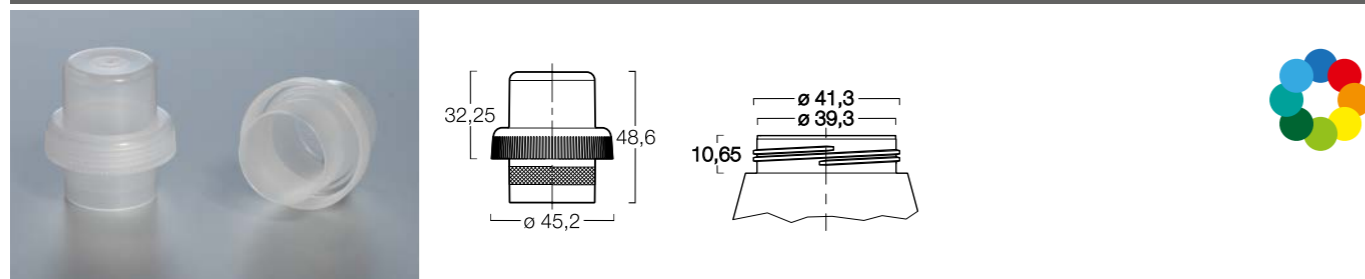

| Artikel-Nr. article no. | Material material | Anbringungsart fixing type | Gewindegröße thread size | Dosiervolumen dosage volume | Dichtung seal | Originalitätsverschluss tamper evidence | Kindersicherung child resistance | Entgasung venting device |
|----------------------------|----------------------|---------------------------------|-----------------------------|--------------------------------|------------------|--|-------------------------------------|-----------------------------|
| 22097..1 | PP | Schraubversion screw version | 42 mm | 30 ml | Konus cone | - | - | ■ |

DOSIER-SCHRAUBVERSCHLÜSSE // DOSAGE SCREW CAPS

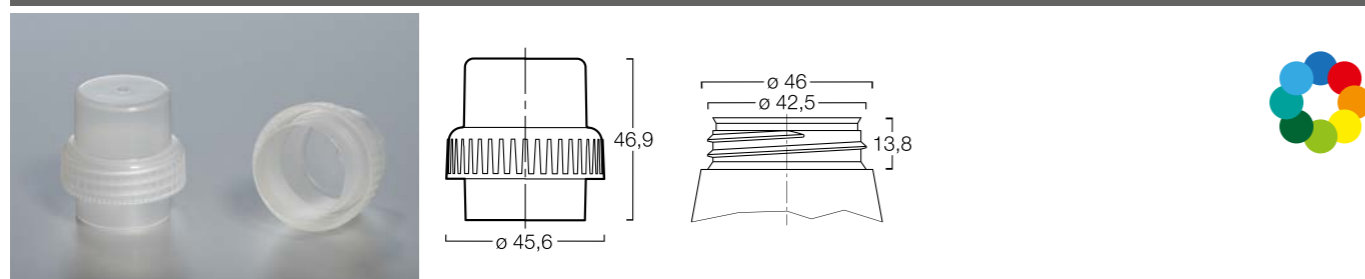

| Artikel-Nr. article no. | Material material | Anbringungsart fixing type | Gewindegröße thread size | Dosiervolumen dosage volume | Dichtung seal | Originalitätsverschluss tamper evidence | Kindersicherung child resistance | Entgasung venting device |
|----------------------------|----------------------|---------------------------------|-----------------------------|--------------------------------|------------------|--|-------------------------------------|-----------------------------|
| 12542..1 | PP | Schraubversion screw version | 43 mm | 40 ml | Konus cone | - | - | - |

DOSIER-SCHRAUBVERSCHLÜSSE // DOSAGE SCREW CAPS

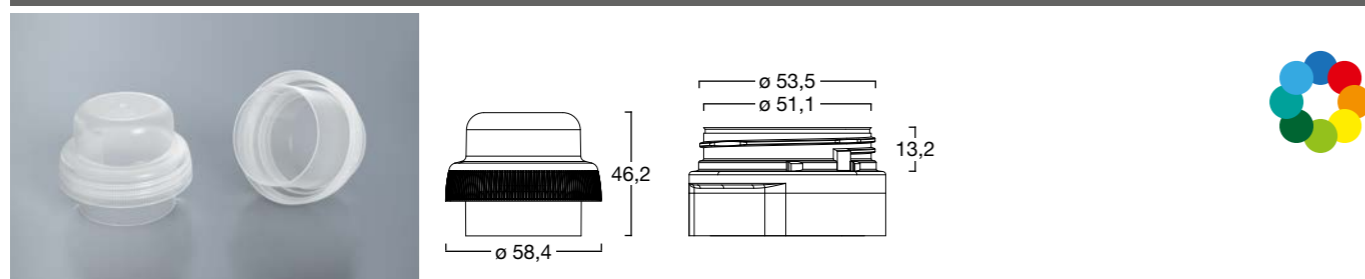

| Artikel-Nr. article no. | Material material | Anbringungsart fixing type | Gewindegröße thread size | Dosiervolumen dosage volume | Dichtung seal | Originalitätsverschluss tamper evidence | Kindersicherung child resistance | Entgasung venting device |
|----------------------------|----------------------|---------------------------------|-----------------------------|--------------------------------|------------------|--|-------------------------------------|-----------------------------|
| 12715..1 | PP | Schraubversion screw version | 53 mm | 60 ml | Konus cone | - | - | - |

DOSIER-SCHRAUBVERSCHLÜSSE // DOSAGE SCREW CAPS

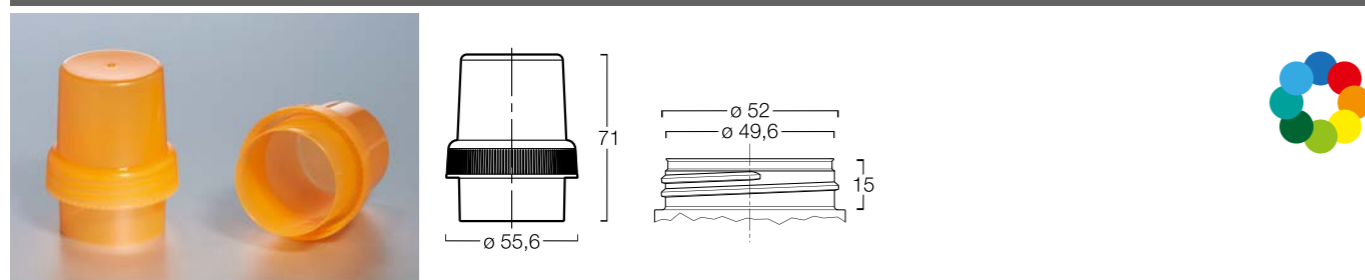

| Artikel-Nr. article no. | Material material | Anbringungsart fixing type | Gewindegröße thread size | Dosiervolumen dosage volume | Dichtung seal | Originalitätsverschluss tamper evidence | Kindersicherung child resistance | Entgasung venting device |
|----------------------------|----------------------|---------------------------------|-----------------------------|--------------------------------|------------------|--|-------------------------------------|-----------------------------|
| 11866..1 | PP | Schraubversion screw version | 53 mm | 100 ml | Konus cone | - | - | - |

DOSIER-SCHRAUBVERSCHLÜSSE // DOSAGE SCREW CAPS

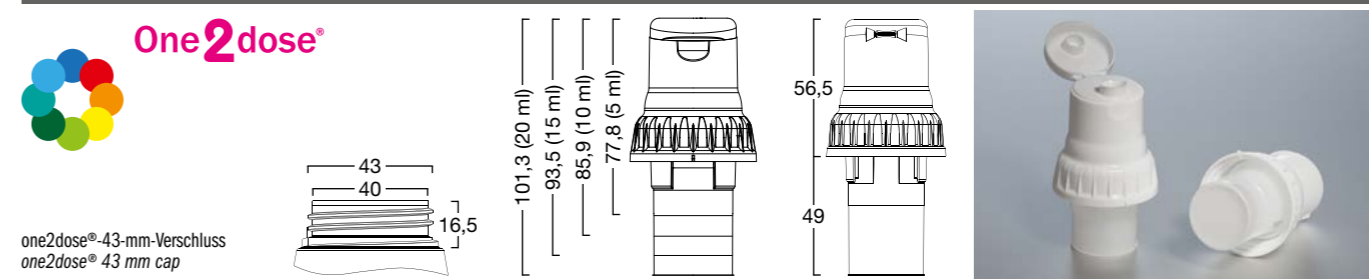

| Artikel-Nr. article no. | Material Oberteil material upper part | Material Dosierkammer material dosage chamber | Anbringungsart fixing type | Gewindegröße thread size | Dosiervolumen dosage volume | Dichtung seal |
|----------------------------|--|--|---------------------------------|-----------------------------|--------------------------------|------------------|
| 33211..4 | PP 2799 | PP 2798 | Schraubversion screw version | 43 mm | 5 ml | Konus cone |
| 33211..3 | PP 2799 | PP 2798 | Schraubversion screw version | 43 mm | 10 ml | Konus cone |
| 33211..2 | PP 2799 | PP 2798 | Schraubversion screw version | 43 mm | 15 ml | Konus cone |
| 33211..1 | PP 2799 | PP 2798 | Schraubversion screw version | 43 mm | 20 ml | Konus cone |

DOSIER-SCHRAUBVERSCHLÜSSE // DOSAGE SCREW CAPS

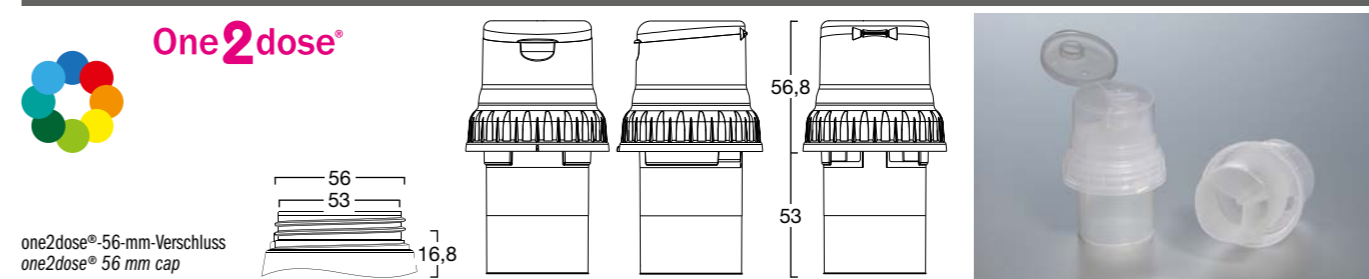

| Artikel-Nr. article no. | Material Oberteil material upper part | Material Dosierkammer material dosage chamber | Anbringungsart fixing type | Gewindegröße thread size | Dosiervolumen dosage volume | Dichtung seal |
|----------------------------|--|--|---------------------------------|-----------------------------|--------------------------------|------------------|
| 33212..2 | PP 2801 | PP 2800 | Schraubversion screw version | 56 mm | 40 ml* | Konus cone |

DOSIER-SCHRAUBVERSCHLÜSSE // DOSAGE SCREW CAPS

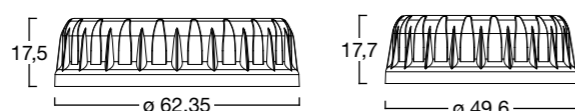

Schraubverschluss (als Nachfüllverschluss für Art.-Nr. 33212..2 und 33211 verwendbar)
screw closure (as refill closure for article no. 33212..2 and 33211) may be used

| Artikel-Nr. article no. | Material material | Anbringungsart fixing type | Gewindegröße thread size | Dichtung seal |
|----------------------------|----------------------|---------------------------------|-----------------------------|------------------|
| 12870..1 | PP | Schraubversion screw version | 56 mm | Konus cone |
| 12920..1 | PP | Schraubversion screw version | 43 mm | Konus cone |

ZWEITEILIGER DOSIER-SCHRAUBVERSCHLUSS // TWO PART DOSAGE SCREW CAP

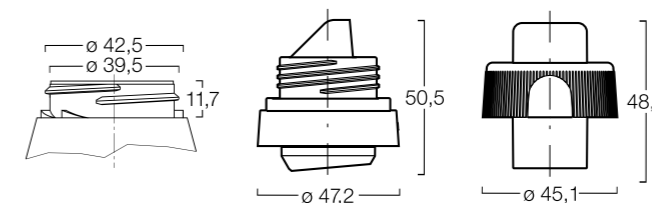

Messbecher mit Ausgießer montiert
doser with pourer assembled



| Artikel-Nr. article no. | Material Dosierer material dosage | Material Ausgießer material pourer | Anbringungsart fixing type | Gewindegröße thread size | Dosiervolumen dosage volume | Dichtung seal | Originalitätsverschluss tamper evidence | Kindersicherung child resistance | Entgasung venting device |
|----------------------------|--------------------------------------|---------------------------------------|---------------------------------|-----------------------------|--------------------------------|------------------|--|-------------------------------------|-----------------------------|
| 33304..1 | PP 1816 | PP 1817 | Schraubversion screw version | 42 mm | 20 ml | Konus cone | - | ■ | - |

ZWEITEILIGER DOSIER-SCHRAUBVERSCHLUSS // TWO PART DOSAGE SCREW CAP

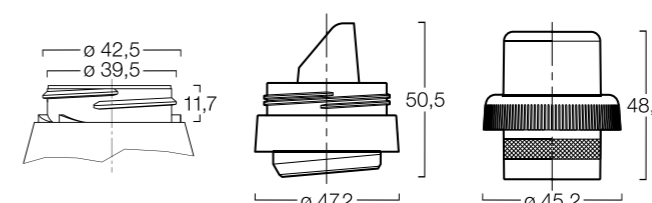

Messbecher mit Ausgießer montiert
doser with pourer assembled



| Artikel-Nr. article no. | Material Dosierer material dosage | Material Ausgießer material pourer | Anbringungsart fixing type | Gewindegröße thread size | Dosiervolumen dosage volume | Dichtung seal | Originalitätsverschluss tamper evidence | Kindersicherung child resistance | Entgasung venting device |
|----------------------------|--------------------------------------|---------------------------------------|---------------------------------|-----------------------------|--------------------------------|------------------|--|-------------------------------------|-----------------------------|
| 34216..1 | PP 2097 | PP 2956 | Schraubversion screw version | 42 mm | 30 ml | Konus cone | - | - | ■ |

ZWEITEILIGER DOSIER-SCHRAUBVERSCHLUSS // TWO PART DOSAGE SCREW CAP

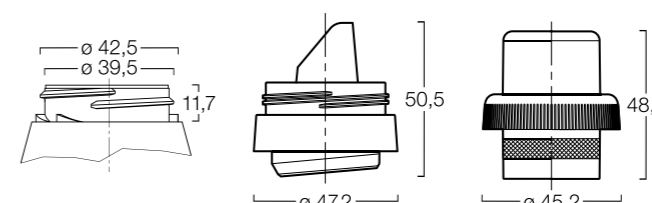

Messbecher mit Ausgießer montiert
doser with pourer assembled



| Artikel-Nr. article no. | Material Dosierer material dosage | Material Ausgießer material pourer | Anbringungsart fixing type | Gewindegröße thread size | Dosiervolumen dosage volume | Dichtung seal | Originalitätsverschluss tamper evidence | Kindersicherung child resistance | Entgasung venting device |
|----------------------------|--------------------------------------|---------------------------------------|---------------------------------|-----------------------------|--------------------------------|------------------|--|-------------------------------------|-----------------------------|
| 33216..1 | PP 2957 | PP 2956 | Schraubversion screw version | 42 mm | 30 ml | Konus cone | - | - | - |

ZWEITEILIGER DOSIER-SCHRAUBVERSCHLUSS // TWO PART DOSAGE SCREW CAP

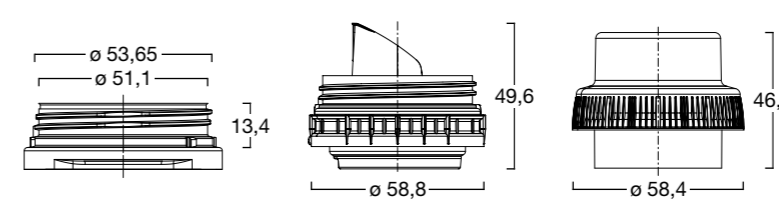

| Artikel-Nr. article no. | Material Dosierer material dosage | Material Ausgießer material pourer | Anbringungsart fixing type | Gewindegröße thread size | Dosiervolumen dosage volume | Dichtung seal | Originalitätsverschluss tamper evidence | Kindersicherung child resistance | Entgasung venting device |
|----------------------------|--------------------------------------|---------------------------------------|---------------------------------|-----------------------------|--------------------------------|------------------|--|-------------------------------------|-----------------------------|
| 33217..1 | PP | PE | Schraubversion screw version | 53 mm | 60 ml | Konus cone | - | - | - |

Eine funktionale Präzision, einfache Handhabung und garantierte Dichtheit bieten die Push-Pull-Verschlüsse. Gerne beraten wir Sie bei der Wahl des richtigen Verschlusses.

Push-pull closures offer precision, simple handling, and guaranteed seal tightness. We would be happy to help you choose the right closure.



PUSH-PULL-VERSCHLÜSSE // PUSH-PULL CAPS

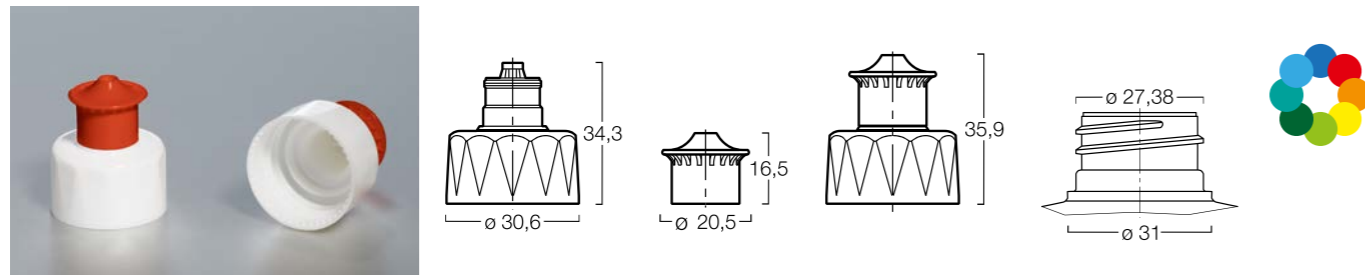

| Artikel-Nr. article no. | Material Oberteil material upper part | Material Unterteil material base part | Anbringungsart fixing type | Gewindegröße thread size | Austrittsöffnung orifice size | Dichtung seal |
|----------------------------|--|--|---------------------------------|-----------------------------|----------------------------------|------------------|
| 52060..A | PE | PP | Schraubversion screw version | 28 / 410 | 1 mm | Konus cone |
| 52060..B | PE | PP | Schraubversion screw version | 28 / 410 | 2,5 mm | Konus cone |
| 52060..C | PE | PP | Schraubversion screw version | 28 / 410 | 3,5 mm | Konus cone |
| 52060..D | PE | PP | Schraubversion screw version | 28 / 410 | 4,5 mm | Konus cone |
| 35109..E | PE | PP | Schraubversion screw version | 28 / 410 | 3 mm | Konus cone |

SCHRAUBVERSCHLÜSSE // SCREW CAPS

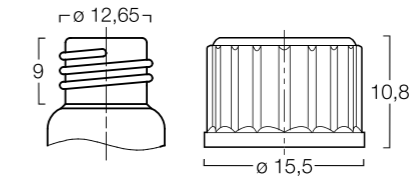

| Artikel-Nr. article no. | Material material | Anbringungsart fixing type | Gewindegröße thread size | Austrittsöffnung orifice size | Dichtung seal | Originalitätsverschluss tamper evidence | Kindersicherung child resistance | Entgasung venting device |
|----------------------------|----------------------|---------------------------------|-----------------------------|----------------------------------|------------------|--|-------------------------------------|-----------------------------|
| 11603..1 | PE | Schraubversion screw version | 13 mm | - | Konus cone | - | - | - |

SCHRAUBVERSCHLÜSSE // SCREW CAPS

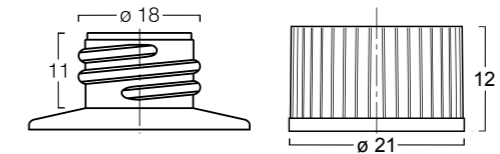

| Artikel-Nr. article no. | Material material | Anbringungsart fixing type | Gewindegröße thread size | Austrittsöffnung orifice size | Dichtung seal | Originalitätsverschluss tamper evidence | Kindersicherung child resistance | Entgasung venting device |
|----------------------------|----------------------|---------------------------------|-----------------------------|----------------------------------|------------------|--|-------------------------------------|-----------------------------|
| 12837..1 | PP | Schraubversion screw version | 18 mm | - | Konus cone | - | - | - |

SCHRAUBVERSCHLÜSSE // SCREW CAPS

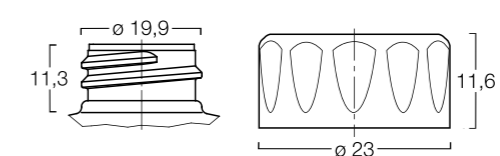

| Artikel-Nr. article no. | Material material | Anbringungsart fixing type | Gewindegröße thread size | Austrittsöffnung orifice size | Dichtung seal | Originalitätsverschluss tamper evidence | Kindersicherung child resistance | Entgasung venting device |
|----------------------------|----------------------|---------------------------------|-----------------------------|----------------------------------|------------------|--|-------------------------------------|-----------------------------|
| 12169..1 | PP | Schraubversion screw version | 20 / 400 | - | Konus cone | - | - | - |

SCHRAUBVERSCHLÜSSE // SCREW CAPS

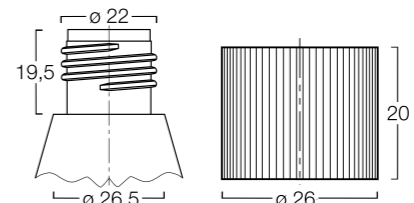

| Artikel-Nr. article no. | Material material | Anbringungsart fixing type | Gewindegröße thread size | Austrittsöffnung orifice size | Dichtung seal | Originalitätsverschluss tamper evidence | Kindersicherung child resistance | Entgasung venting device |
|----------------------------|----------------------|---------------------------------|-----------------------------|----------------------------------|------------------|--|-------------------------------------|-----------------------------|
| 11380..1 | PE | Schraubversion screw version | 22 mm | - | Konus cone | - | - | - |

SCHRAUBVERSCHLÜSSE // SCREW CAPS

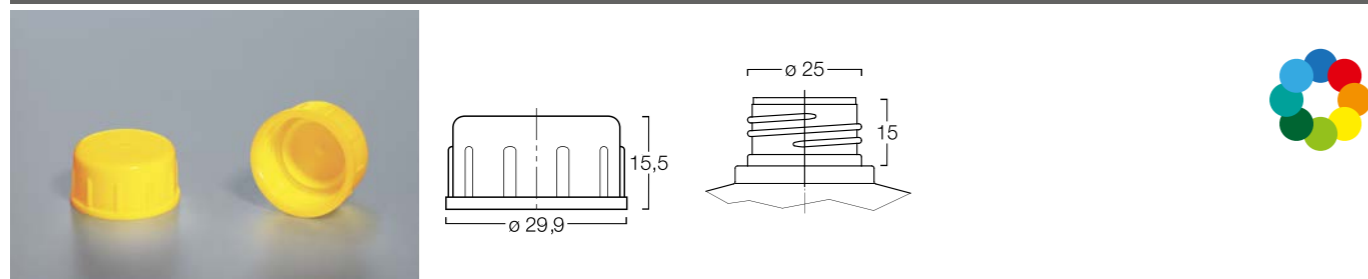

| Artikel-Nr. article no. | Material material | Anbringungsart fixing type | Gewindegröße thread size | Austrittsöffnung orifice size | Dichtung seal | Originalitätsverschluss tamper evidence | Kindersicherung child resistance | Entgasung venting device |
|----------------------------|----------------------|---------------------------------|-----------------------------|----------------------------------|------------------|--|-------------------------------------|-----------------------------|
| 10640..1 | PE | Schraubversion screw version | 25 mm | - | Konus cone | - | - | - |

SCHRAUBVERSCHLÜSSE // SCREW CAPS

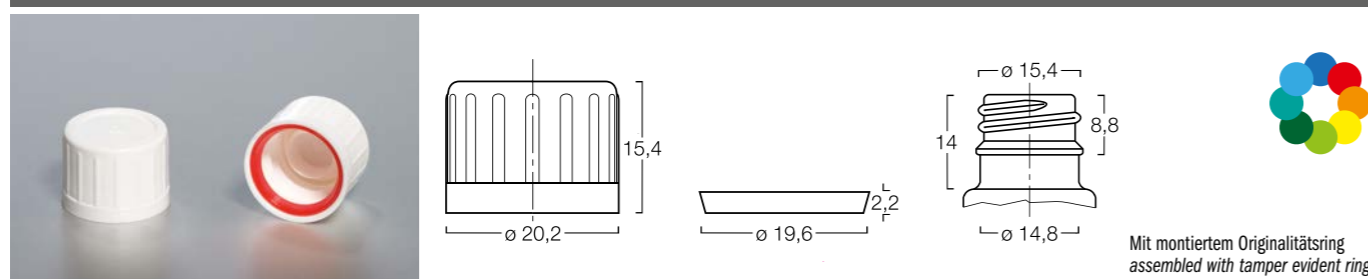

| Artikel-Nr. article no. | Material Verschluss material closure | Material Ring material ring | Anbringungsart fixing type | Gewindegröße thread size | Austrittsöffnung orifice size | Dichtung seal | Originalitätsverschluss tamper evidence | Kindersicherung child resistance | Entgasung venting device |
|----------------------------|---|--------------------------------|---------------------------------|-----------------------------|----------------------------------|------------------|--|-------------------------------------|-----------------------------|
| 31210..1 | PP | PP | Schraubversion screw version | 16 mm | - | Konus cone | ■ | - | - |
| 31209..1 | PP | PP | Schraubversion screw version | 16 mm | - | - | ■ | - | - |

SCHRAUBVERSCHLÜSSE // SCREW CAPS

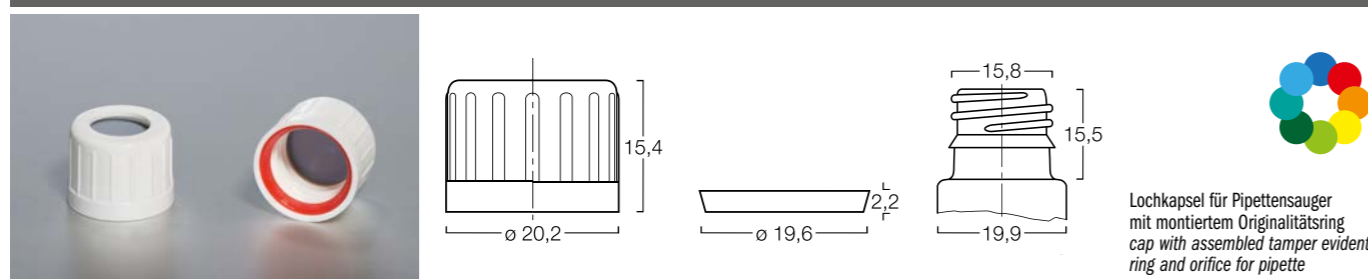

| Artikel-Nr. article no. | Material Verschluss material closure | Material Ring material ring | Anbringungsart fixing type | Gewindegröße thread size | Lochgröße bore size | Dichtung seal | Originalitätsverschluss tamper evidence | Kindersicherung child resistance | Entgasung venting device |
|----------------------------|---|--------------------------------|---------------------------------|-----------------------------|------------------------|------------------|--|-------------------------------------|-----------------------------|
| 31206..1 | PP | PP | Schraubversion screw version | 16 mm | 11,5 mm | - | ■ | - | - |

SCHRAUBVERSCHLÜSSE // SCREW CAPS

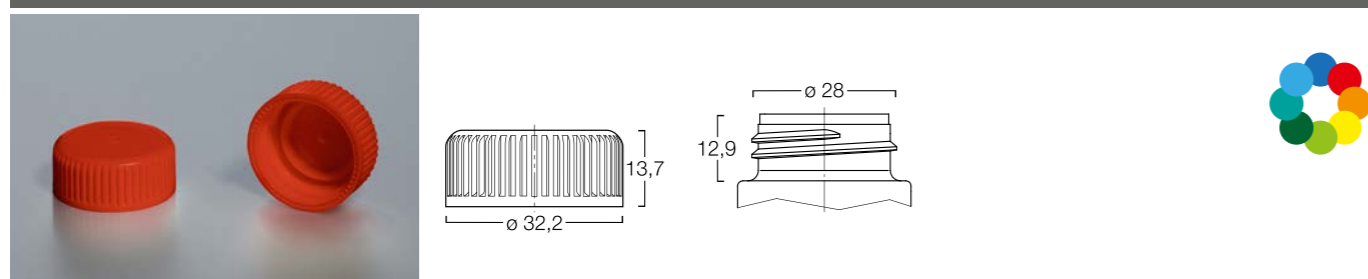

| Artikel-Nr. article no. | Material material | Anbringungsart fixing type | Gewindegröße thread size | Austrittsöffnung orifice size | Dichtung seal | Originalitätsverschluss tamper evidence | Kindersicherung child resistance | Entgasung venting device |
|----------------------------|----------------------|---------------------------------|-----------------------------|----------------------------------|------------------|--|-------------------------------------|-----------------------------|
| 52125..1 | PP | Schraubversion screw version | 28 mm | - | Konus cone | - | - | - |

SCHRAUBVERSCHLÜSSE // SCREW CAPS

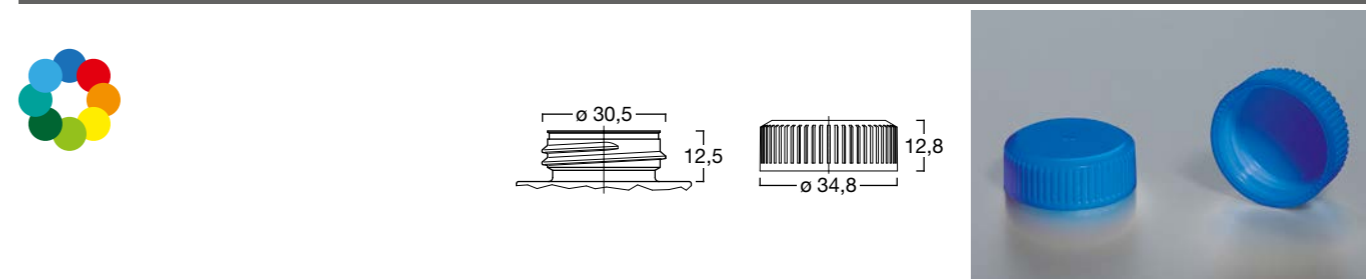

| Artikel-Nr. article no. | Material material | Anbringungsart fixing type | Gewindegröße thread size | Austrittsöffnung orifice size | Dichtung seal | Originalitätsverschluss tamper evidence | Kindersicherung child resistance | Entgasung venting device |
|----------------------------|----------------------|---------------------------------|-----------------------------|----------------------------------|------------------|--|-------------------------------------|-----------------------------|
| 11299..1 | PP | Schraubversion screw version | 30 mm | - | Konus cone | - | - | - |
| 21429..1 | PP | Schraubversion screw version | 30 mm | - | Einlage liner | - | - | - |

SCHRAUBVERSCHLÜSSE // SCREW CAPS

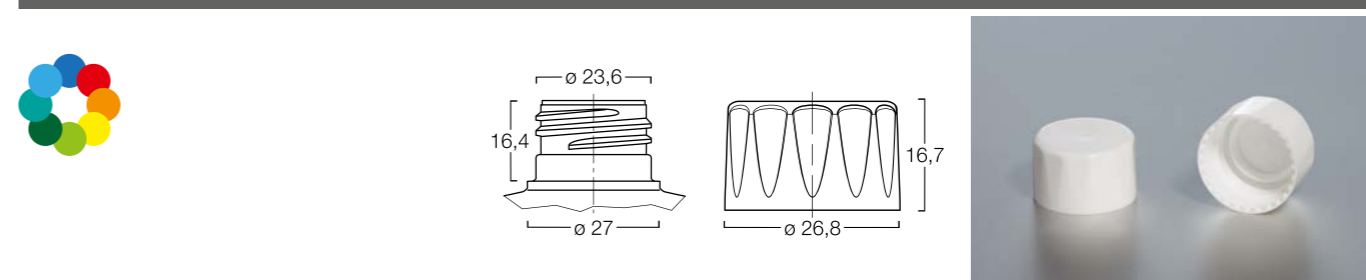

| Artikel-Nr. article no. | Material material | Anbringungsart fixing type | Gewindegröße thread size | Austrittsöffnung orifice size | Dichtung seal | Originalitätsverschluss tamper evidence | Kindersicherung child resistance | Entgasung venting device |
|----------------------------|----------------------|---------------------------------|-----------------------------|----------------------------------|------------------|--|-------------------------------------|-----------------------------|
| 12602..1 | PP | Schraubversion screw version | 24 / 410 | - | Konus cone | - | - | - |

SCHRAUBVERSCHLÜSSE // SCREW CAPS

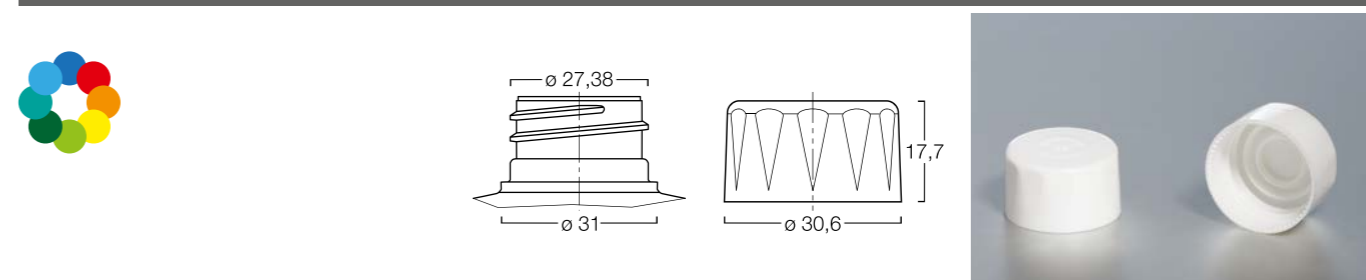

| Artikel-Nr. article no. | Material material | Anbringungsart fixing type | Gewindegröße thread size | Austrittsöffnung orifice size | Dichtung seal | Originalitätsverschluss tamper evidence | Kindersicherung child resistance | Entgasung venting device |
|----------------------------|----------------------|---------------------------------|-----------------------------|----------------------------------|------------------|--|-------------------------------------|-----------------------------|
| 21916..1 | PP | Schraubversion screw version | 28 / 410 | - | Konus cone | - | - | ■ |

SCHRAUBVERSCHLÜSSE // SCREW CAPS

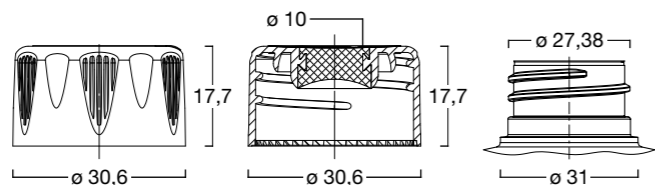

Wachsverschluss - für Reinigungsmittel
in Geschirrspülmaschine
Wax Cap - for detergents for
dishwashers



| Artikel-Nr. article no. | Material material | Anbringungsart fixing type | Gewindegröße thread size | Austrittsöffnung orifice size | Dichtung seal | Originalitätsverschluss tamper evidence | Kindersicherung child resistance | Entgasung venting device |
|----------------------------|----------------------|---------------------------------|-----------------------------|----------------------------------|------------------|--|-------------------------------------|-----------------------------|
| 22918..1 | PP | Schraubversion screw version | 28 / 410 | - | Konus cone | - | - | - |

SCHRAUBVERSCHLÜSSE // SCREW CAPS

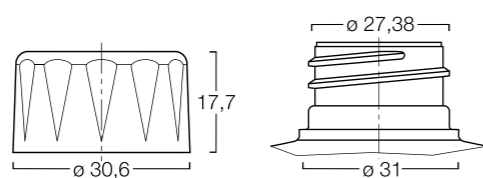

| Artikel-Nr. article no. | Material material | Anbringungsart fixing type | Gewindegröße thread size | Austrittsöffnung orifice size | Dichtung seal | Originalitätsverschluss tamper evidence | Kindersicherung child resistance | Entgasung venting device |
|----------------------------|----------------------|---------------------------------|-----------------------------|----------------------------------|------------------|--|-------------------------------------|-----------------------------|
| 11794..1 | PP | Schraubversion screw version | 28 / 410 | - | Konus cone | - | - | - |

SCHRAUBVERSCHLÜSSE // SCREW CAPS

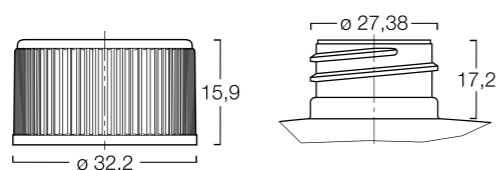

Öffnungsprinzip: drücken und drehen
opening by press and turn



| Artikel-Nr. article no. | Material Oberteil material upper part | Material Unterteil material lower part | Anbringungsart fixing type | Gewindegröße thread size | Austrittsöffnung orifice size | Dichtung seal | Originalitätsverschluss tamper evidence | Kindersicherung child resistance | Entgasung venting device |
|--|--|---|---------------------------------|-----------------------------|----------------------------------|------------------|--|-------------------------------------|-----------------------------|
| 31602..1 | PP | PP | Schraubversion screw version | 28 / 410 | - | Einlage liner | - | ■ | - |
| 31606..2 | PP | PP | Schraubversion screw version | 28 / 410 | - | Konus cone | - | ■ | - |
| 31602..4 | PP | PP | Schraubversion screw version | 28 / 410 | - | Konus cone | - | ■ | ■ |
| MIT PE-SPRITZER MONTIERT // WITH PE-PLUG ASSEMBLED | | | | | | | | | |
| 31602..3 | PP | PP | Schraubversion screw version | 28 / 410 | 2 mm | Dorn spigot | - | ■ | - |

SCHRAUBVERSCHLÜSSE // SCREW CAPS

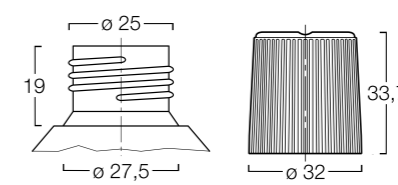

Öffnungsprinzip: drücken und drehen
press and turn to open



| Artikel-Nr. article no. | Material Außenteil material outside part | Material Innenteil material inner part | Material Spritzer material plug | Anbringungsart fixing type | Gewindegröße thread size | Austrittsöffnung orifice size | Dichtung seal | Kindersicherung child resistance | Entgasung venting device |
|----------------------------|---|---|------------------------------------|---------------------------------|-----------------------------|----------------------------------|------------------|-------------------------------------|-----------------------------|
| 33302..1 | PP | PP | PE | Schraubversion screw version | 25 mm | 3 mm | Dorn spigot | ■ | - |

APPLIKATOR-VERSCHLÜSSE // APPLICATORS

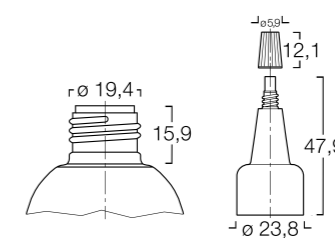

Applikator, montiert
applicator, assembled



| Artikel-Nr. article no. | Material Verschluss material closure | Material Kappe material cap | Anbringungsart fixing type | Gewindegröße thread size | Austrittsöffnung orifice size | Dichtung seal | Originalitätsverschluss tamper evidence | Kindersicherung child resistance | Entgasung venting device |
|----------------------------|---|--------------------------------|---------------------------------|-----------------------------|----------------------------------|------------------|--|-------------------------------------|-----------------------------|
| 33715..1 | PP | PP | Schraubversion screw version | 19 mm | 1 mm | Konus cone | - | - | - |
| 33715..2 | PP | PP | Schraubversion screw version | 19 mm | 2 mm | Konus cone | - | - | - |
| 33715..3 | PP | PP | Schraubversion screw version | 19 mm | 0,8 mm | Konus cone | - | - | - |
| 33715..4 | PP | PP | Schraubversion screw version | 19 mm | 0,5 mm | Konus cone | - | - | - |

APPLIKATOR-VERSCHLÜSSE // APPLICATORS

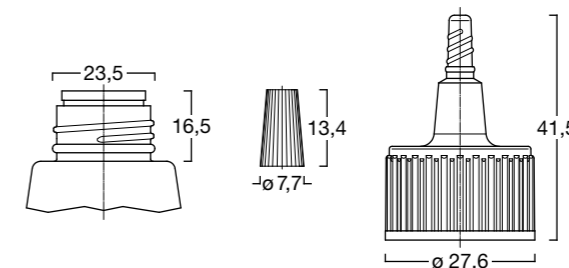

Applikator, montiert
applicator, assembled



| Artikel-Nr. article no. | Material Verschluss material closure | Material Kappe material cap | Anbringungsart fixing type | Gewindegröße thread size | Austrittsöffnung orifice size | Dichtung seal | Originalitätsverschluss tamper evidence | Kindersicherung child resistance | Entgasung venting device |
|----------------------------|---|--------------------------------|---------------------------------|-----------------------------|----------------------------------|------------------|--|-------------------------------------|-----------------------------|
| 33713..1 | PE | PE | Schraubversion screw version | 24 mm | 2 mm | Konus cone | - | - | - |

APPLIKATOR-VERSCHLÜSSE // APPLICATORS

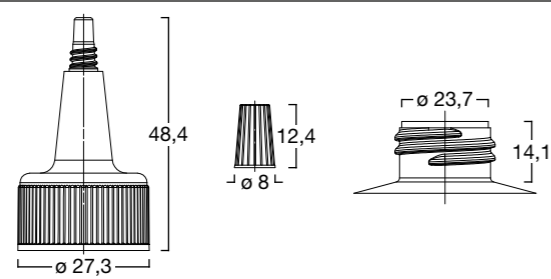

Applikator, montiert
applicator, assembled

| Artikel-Nr. article no. | Material Verschluss material closure | Material Kappe material cap | Anbringungsart fixing type | Gewindegröße thread size | Austrittsöffnung orifice size | Dichtung seal | Originalitätsverschluss tamper evidence | Kindersicherung child resistance | Entgasung venting device |
|----------------------------|---|--------------------------------|---------------------------------|-----------------------------|----------------------------------|------------------|--|-------------------------------------|-----------------------------|
| 33712..2 | PP | PE | Schraubversion screw version | 24 mm | 2 mm | Konus cone | - | - | - |

APPLIKATOR-VERSCHLÜSSE // APPLICATORS

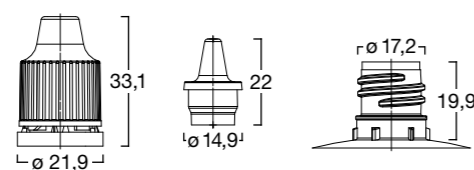

Spritzer und Kappe nicht montiert
plug and cap not assembled

| Artikel-Nr. article no. | Material Verschluss material closure | Material Spritzer material plug | Anbringungsart fixing type | Gewindegröße thread size | Austrittsöffnung orifice size | Dichtung seal | Originalitätsverschluss tamper evidence | Kindersicherung child resistance | Entgasung venting device |
|----------------------------|---|------------------------------------|---------------------------------|-----------------------------|----------------------------------|------------------|--|-------------------------------------|-----------------------------|
| 12459..1 | - | PE | - | - | 1 mm | Konus cone | - | - | - |
| 12460..1 | PP | - | Schraubversion screw version | 17 mm | - | Dorn spigot | ■ | - | - |

APPLIKATOR-VERSCHLÜSSE // APPLICATORS

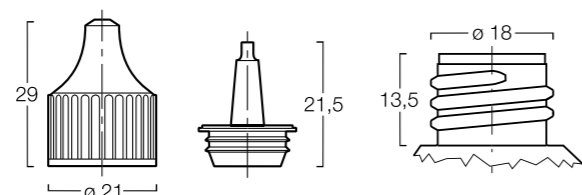

Mit PE-Spritzer montiert
assembled with PE-plug

| Artikel-Nr. article no. | Material Verschluss material closure | Material Spritzer material plug | Anbringungsart fixing type | Gewindegröße thread size | Austrittsöffnung orifice size | Dichtung seal | Originalitätsverschluss tamper evidence | Kindersicherung child resistance | Entgasung venting device |
|----------------------------|---|------------------------------------|---------------------------------|-----------------------------|----------------------------------|------------------|--|-------------------------------------|-----------------------------|
| 33806..1 | PP | PE | Schraubversion screw version | 18 mm | 1 mm | Dorn spigot | - | - | - |

Für unterschiedlichste Füllgüter eignen sich die Klappscharnier-Verschlüsse von MENSHEN. Durch eine präzise Fertigung wird absolute Dichtheit sowie Zuverlässigkeit garantiert.

MENSHEN flip-top closures are suitable for a wide range of filling contents. With their precise production, absolute seal tightness and reliability are guaranteed.



Artikel/Article (12851..1) Seite 28/Page 28

KLAPPSCHARNIER-SCHRAUBVERSCHLÜSSE // FLIP-TOP SCREW CAPS

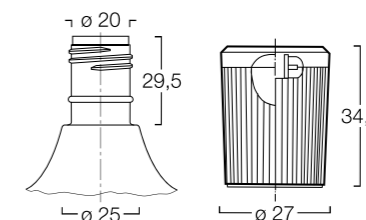

| Artikel-Nr. article no. | Material material | Anbringungsart fixing type | Gewindegröße thread size | Austrittsöffnung orifice size | Dichtung seal | Originalitätsverschluss tamper evidence | Kindersicherung child resistance | Entgasung venting device |
|----------------------------|----------------------|---------------------------------|-----------------------------|----------------------------------|------------------|--|-------------------------------------|-----------------------------|
| 11110..1 | PP | Schraubversion screw version | 20 mm | 2 mm | Konus cone | - | - | - |

KLAPPSCHARNIER-SCHRAUBVERSCHLÜSSE // FLIP-TOP SCREW CAPS

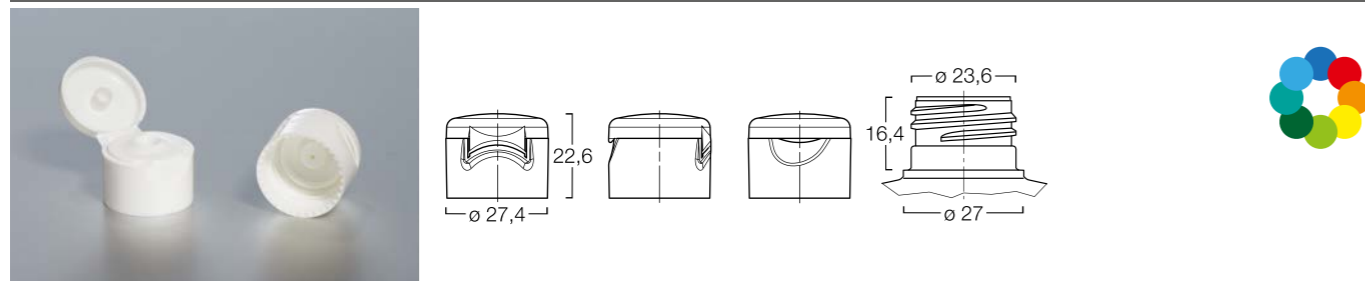

| Artikel-Nr. article no. | Material material | Anbringungsart fixing type | Gewindegröße thread size | Austrittsöffnung orifice size | Dichtung seal | Originalitätsverschluss tamper evidence | Kindersicherung child resistance | Entgasung venting device |
|----------------------------|----------------------|---------------------------------|-----------------------------|----------------------------------|------------------|--|-------------------------------------|-----------------------------|
| 12826.1 | PP | Schraubversion screw version | 24 / 410 | 1,5 mm | Konus cone | - | - | - |
| 12826.3 | PP | Schraubversion screw version | 24 / 410 | 3 mm | Konus cone | - | - | - |
| 12826.2 | PP | Schraubversion screw version | 24 / 410 | 4,4 mm | Konus cone | - | - | - |
| 52128.1 | PP | Schraubversion screw version | 24 / 410 | 3 mm | Konus cone | - | - | - |
| 52128.2 | PP | Schraubversion screw version | 24 / 410 | 1,5 mm | Konus cone | - | - | - |
| 52128.3 | PP | Schraubversion screw version | 24 / 410 | 4,4 mm | Konus cone | - | - | - |

KLAPPSCHARNIER-SCHRAUBVERSCHLÜSSE // FLIP-TOP SCREW CAPS

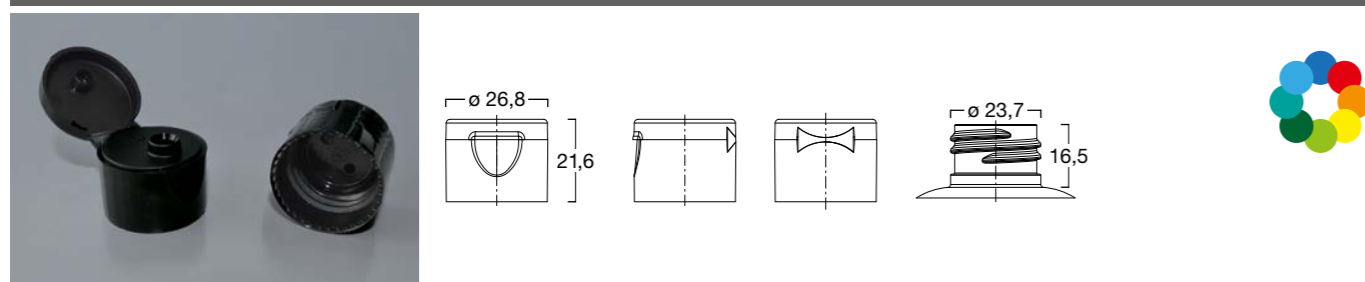

| Artikel-Nr. article no. | Material material | Anbringungsart fixing type | Gewindegröße thread size | Austrittsöffnung orifice size | Dichtung seal | Originalitätsverschluss tamper evidence | Kindersicherung child resistance | Entgasung venting device |
|----------------------------|----------------------|---------------------------------|-----------------------------|----------------------------------|------------------|--|-------------------------------------|-----------------------------|
| 12832.1 | PP | Schraubversion screw version | 24 / 410 | 3 mm | Konus cone | - | - | - |

KLAPPSCHARNIER-SCHRAUBVERSCHLÜSSE // FLIP-TOP SCREW CAPS

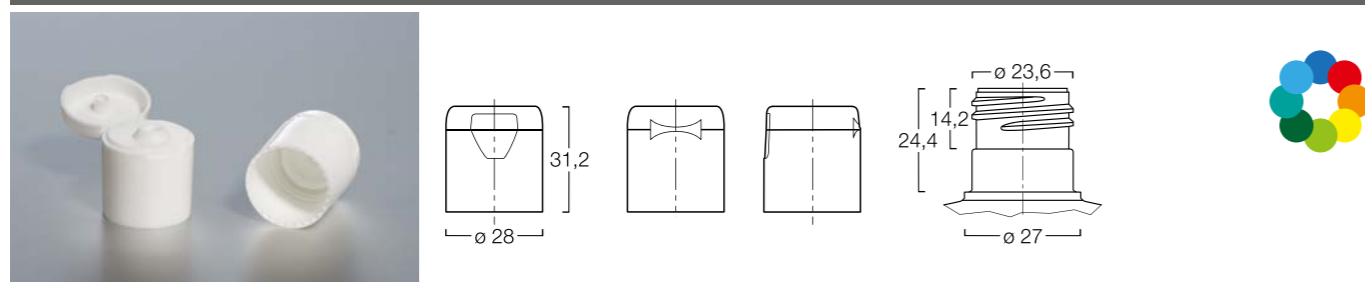

| Artikel-Nr. article no. | Material material | Anbringungsart fixing type | Gewindegröße thread size | Austrittsöffnung orifice size | Dichtung seal | Originalitätsverschluss tamper evidence | Kindersicherung child resistance | Entgasung venting device |
|----------------------------|----------------------|---------------------------------|-----------------------------|----------------------------------|------------------|--|-------------------------------------|-----------------------------|
| 12848.1 | PP | Schraubversion screw version | 24 / 415 | 4 mm | Konus cone | - | - | - |
| 12848.3 | PP | Schraubversion screw version | 24 / 415 | 2 mm | Konus cone | - | - | - |

KLAPPSCHARNIER-SCHRAUBVERSCHLÜSSE // FLIP-TOP SCREW CAPS

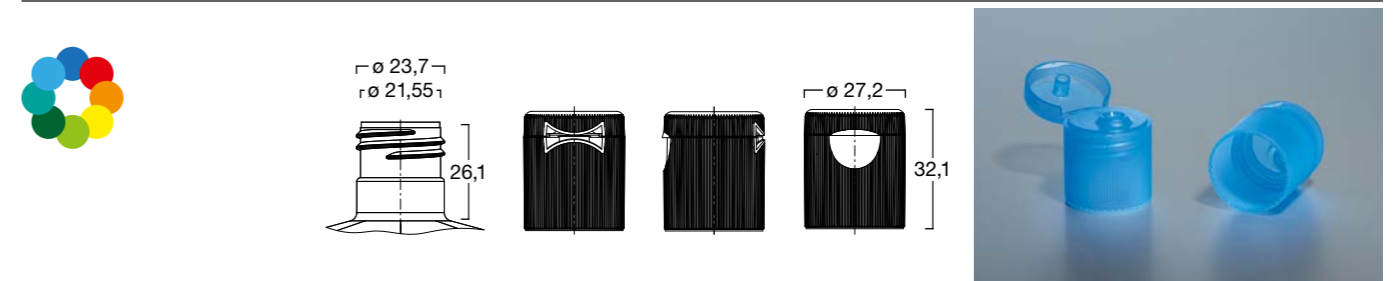

| Artikel-Nr. article no. | Material material | Anbringungsart fixing type | Gewindegröße thread size | Austrittsöffnung orifice size | Dichtung seal | Originalitätsverschluss tamper evidence | Kindersicherung child resistance | Entgasung venting device |
|----------------------------|----------------------|---------------------------------|-----------------------------|----------------------------------|------------------|--|-------------------------------------|-----------------------------|
| 12830.1 | PP | Schraubversion screw version | 24 / 415 | 4,5 mm | Konus cone | - | - | - |

KLAPPSCHARNIER-SCHRAUBVERSCHLÜSSE // FLIP-TOP SCREW CAPS

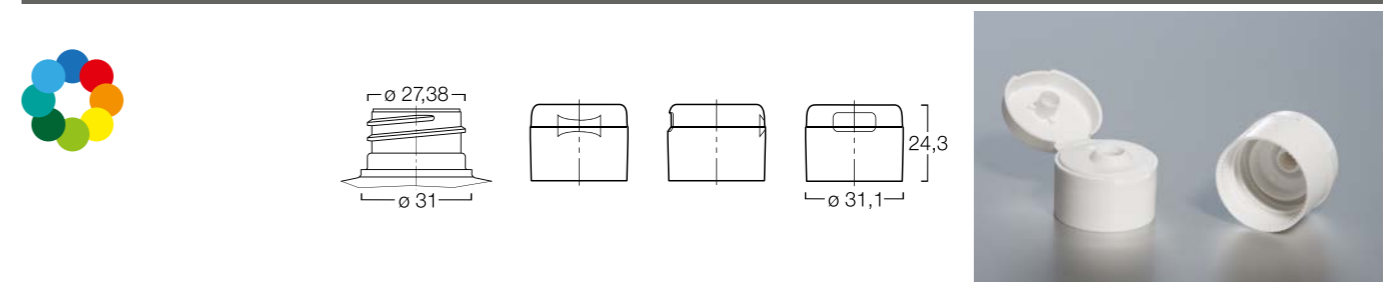

| Artikel-Nr. article no. | Material material | Anbringungsart fixing type | Gewindegröße thread size | Austrittsöffnung orifice size | Dichtung seal | Originalitätsverschluss tamper evidence | Kindersicherung child resistance | Entgasung venting device |
|----------------------------|----------------------|---------------------------------|-----------------------------|----------------------------------|------------------|--|-------------------------------------|-----------------------------|
| 12972.1 | PP | Schraubversion screw version | 28 / 410 | 2,4,6 mm | Konus cone | - | - | - |

KLAPPSCHARNIER-SCHRAUBVERSCHLÜSSE // FLIP-TOP SCREW CAPS

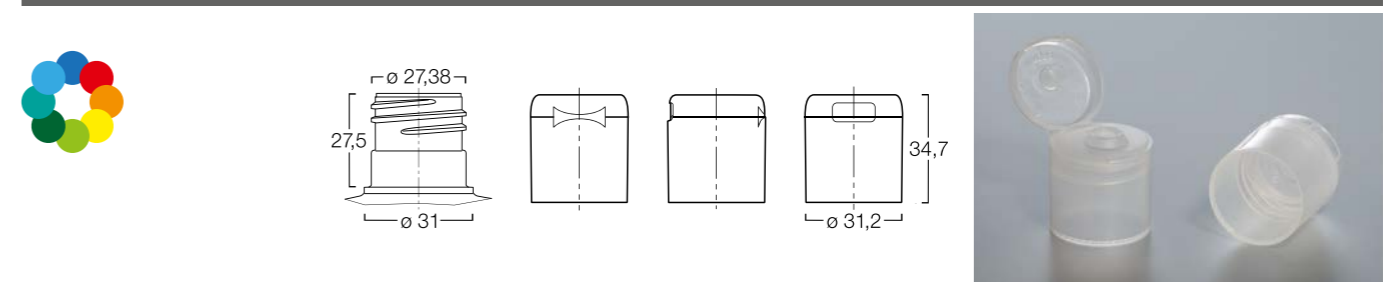

| Artikel-Nr. article no. | Material material | Anbringungsart fixing type | Gewindegröße thread size | Austrittsöffnung orifice size | Dichtung seal | Originalitätsverschluss tamper evidence | Kindersicherung child resistance | Entgasung venting device |
|----------------------------|----------------------|---------------------------------|-----------------------------|----------------------------------|------------------|--|-------------------------------------|-----------------------------|
| 12035.1 | PP | Schraubversion screw version | 28 / 415 | 6 mm | Konus cone | - | - | - |

KLAPPSCHARNIER-SCHRAUBVERSCHLÜSSE // FLIP-TOP SCREW CAPS

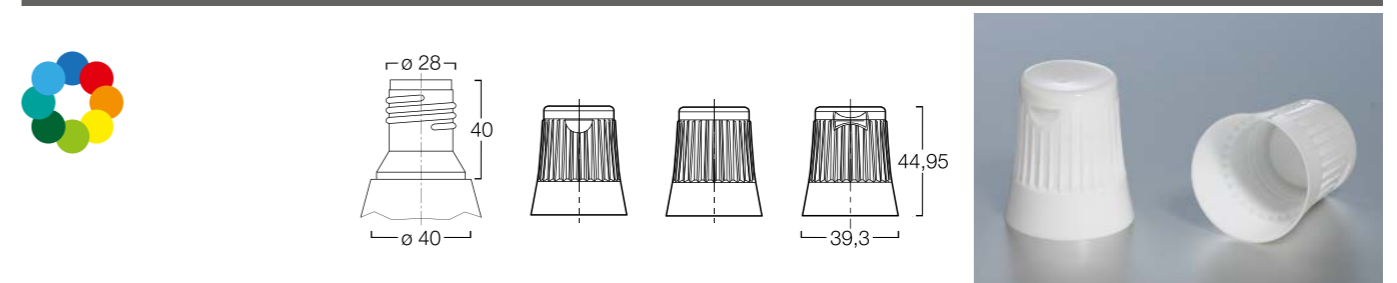

| Artikel-Nr. article no. | Material material | Anbringungsart fixing type | Gewindegröße thread size | Austrittsöffnung orifice size | Dichtung seal | Originalitätsverschluss tamper evidence | Kindersicherung child resistance | Entgasung venting device |
|----------------------------|----------------------|---------------------------------|-----------------------------|----------------------------------|------------------|--|-------------------------------------|-----------------------------|
| 11863.1 | PP | Schraubversion screw version | 28 mm | 4 mm | Konus cone | - | - | - |

KLAPPSCHARNIER-PRELLVERSCHLÜSSE // FLIP-TOP PUSH ON CAPS

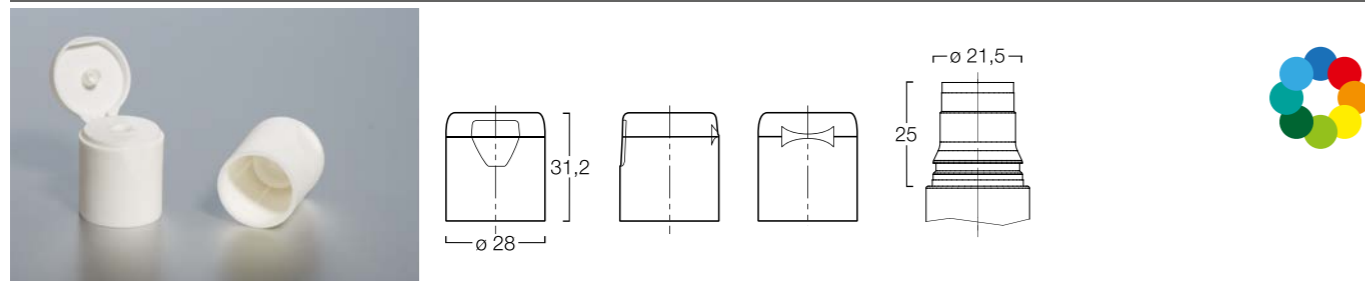

| Artikel-Nr. article no. | Material material | Anbringungsart fixing type | Gewindegröße thread size | Austrittsöffnung orifice size | Dichtung seal | Originalitätsverschluss tamper evidence | Kindersicherung child resistance | Entgasung venting device |
|----------------------------|----------------------|---------------------------------|-----------------------------|----------------------------------|------------------|--|-------------------------------------|-----------------------------|
| 52057..1 | PP | Prellversion push on version | - | 3,5 mm | Konus cone | - | - | - |

KLAPPSCHARNIER-PRELLVERSCHLÜSSE // FLIP-TOP PUSH ON CAPS

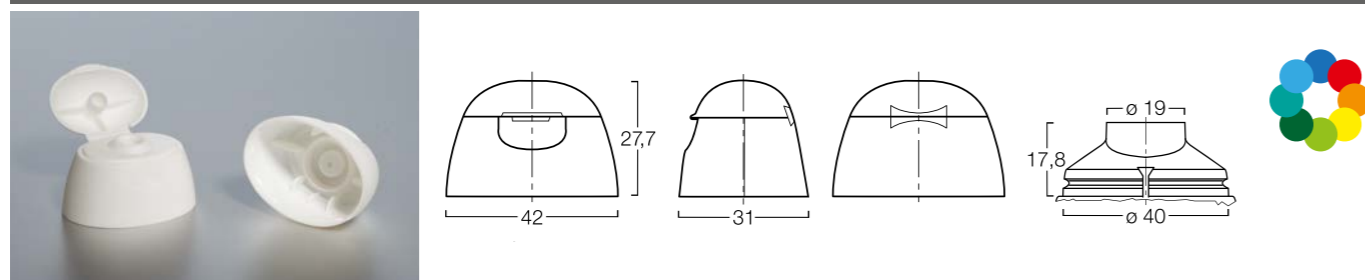

| Artikel-Nr. article no. | Material material | Anbringungsart fixing type | Gewindegröße thread size | Austrittsöffnung orifice size | Dichtung seal | Originalitätsverschluss tamper evidence | Kindersicherung child resistance | Entgasung venting device |
|----------------------------|----------------------|---------------------------------|-----------------------------|----------------------------------|------------------|--|-------------------------------------|-----------------------------|
| 52126..1 | PP | Prellversion push on version | - | 6 mm | Konus cone | - | - | - |
| 52126..2 | PP | Prellversion push on version | - | 2 mm | Konus cone | - | - | - |
| 52126..3 | PP | Prellversion push on version | - | 4 mm | Konus cone | - | - | - |

KLAPPSCHARNIER-PRELLVERSCHLÜSSE // FLIP-TOP PUSH ON CAPS

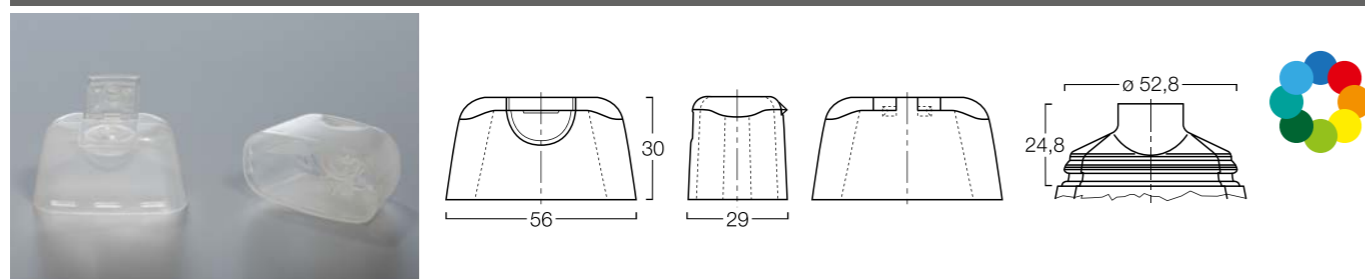

| Artikel-Nr. article no. | Material material | Anbringungsart fixing type | Gewindegröße thread size | Austrittsöffnung orifice size | Dichtung seal | Originalitätsverschluss tamper evidence | Kindersicherung child resistance | Entgasung venting device |
|----------------------------|----------------------|---------------------------------|-----------------------------|----------------------------------|------------------|--|-------------------------------------|-----------------------------|
| 11809..1 | PP | Prellversion push on version | - | 7 mm | Konus cone | - | - | - |
| 11809..2 | PP | Prellversion push on version | - | 3 mm | Konus cone | - | - | - |

KLAPPSCHARNIER-PRELLVERSCHLÜSSE // FLIP-TOP PUSH ON CAPS

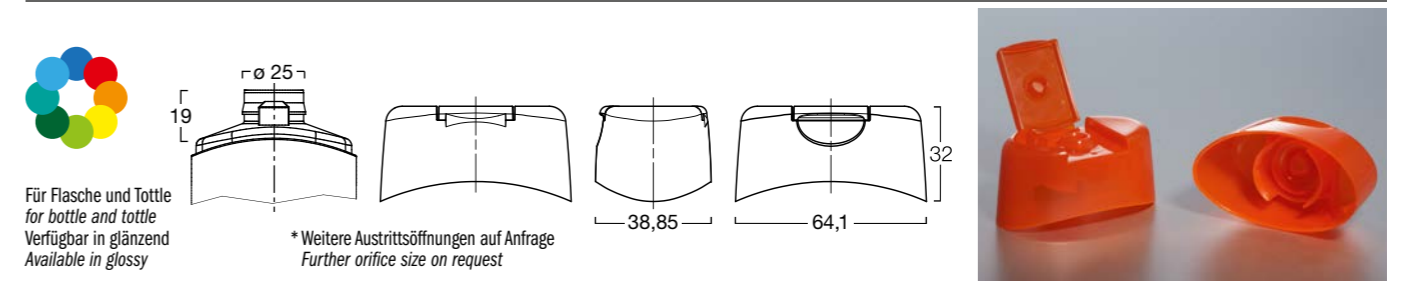

| Artikel-Nr. article no. | Material material | Anbringungsart fixing type | Gewindegröße thread size | Austrittsöffnung orifice size | Dichtung seal | Originalitätsverschluss tamper evidence | Kindersicherung child resistance | Entgasung venting device |
|----------------------------|----------------------|---------------------------------|-----------------------------|----------------------------------|------------------|--|-------------------------------------|-----------------------------|
| 13009..1* | PP | Prellversion push on version | - | 6 mm | Konus cone | - | - | - |

KLAPPSCHARNIER-PRELLVERSCHLÜSSE // FLIP-TOP PUSH ON CAPS

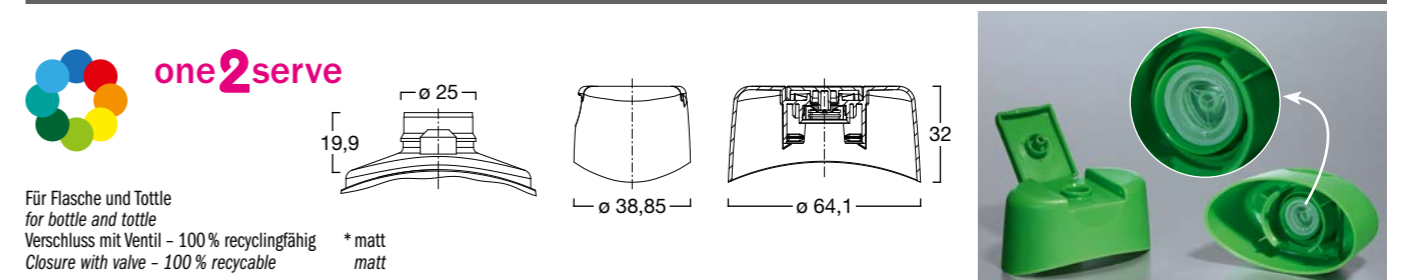

| Artikel-Nr. article no. | Material material | Anbringungsart fixing type | Gewindegröße thread size | Austrittsöffnung orifice size | Dichtung seal | Originalitätsverschluss tamper evidence | Kindersicherung child resistance | Entgasung venting device |
|----------------------------|----------------------|---------------------------------|-----------------------------|----------------------------------|------------------|--|-------------------------------------|-----------------------------|
| 35604..1* | PP | Prellversion push on version | - | - | Konus cone | - | - | - |

KLAPPSCHARNIER-PRELLVERSCHLÜSSE // FLIP-TOP PUSH ON CAPS



One2close®

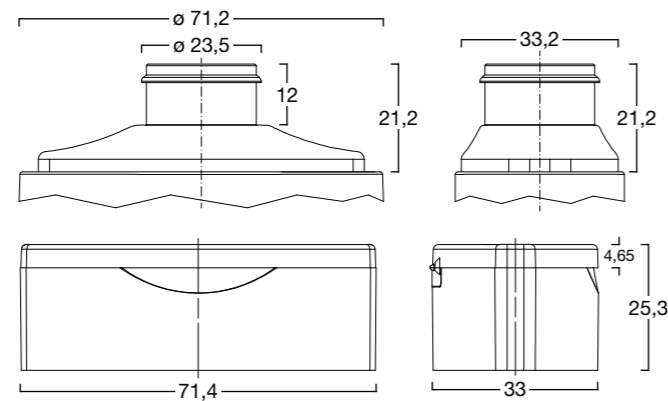

| Artikel-Nr. article no. | Material material | Anbringungsart fixing type | Gewindegröße thread size | Austrittsöffnung orifice size | Dichtung seal | Originalitätsverschluss tamper evidence | Kindersicherung child resistance | Entgasung venting device |
|----------------------------|----------------------|---------------------------------|-----------------------------|----------------------------------|------------------|--|-------------------------------------|-----------------------------|
| 12851..1 | PP | Prellversion push on version | - | 4,2 mm | Konus cone | - | - | - |
| 12851..2 | PP | Prellversion push on version | - | 3 mm | Konus cone | - | - | - |

KLAPPSCHARNIER-PRELLVERSCHLÜSSE // FLIP-TOP PUSH ON CAPS



One2close® mini

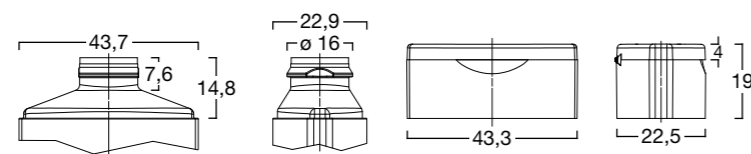

| Artikel-Nr. article no. | Material material | Anbringungsart fixing type | Gewindegröße thread size | Austrittsöffnung orifice size | Dichtung seal | Originalitätsverschluss tamper evidence | Kindersicherung child resistance | Entgasung venting device |
|----------------------------|----------------------|---------------------------------|-----------------------------|----------------------------------|------------------|--|-------------------------------------|-----------------------------|
| 12903..1 | PP | Prellversion push on version | - | 3 mm | Konus cone | - | - | - |

KIPPHEBEL-SCHRAUBVERSCHLÜSSE // TURRET SCREW CAPS

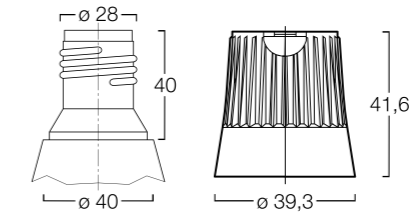

| Artikel-Nr. article no. | Material Verschluss material closure | Material Kipphebel material turret | Anbringungsart fixing type | Gewindegröße thread size | Austrittsöffnung orifice size | Dichtung seal | Originalitätsverschluss tamper evidence | Kindersicherung child resistance | Entgasung venting device |
|----------------------------|---|---------------------------------------|---------------------------------|-----------------------------|----------------------------------|------------------|--|-------------------------------------|-----------------------------|
| 35203..1 | PP | PP | Schraubversion screw version | 28 mm | 4 mm | Konus cone | - | - | - |

KIPPHEBEL-SCHRAUBVERSCHLÜSSE // TURRET SCREW CAPS

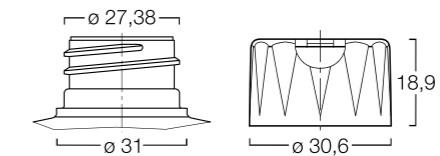

| Artikel-Nr. article no. | Material Verschluss material closure | Material Kipphebel material turret | Anbringungsart fixing type | Gewindegröße thread size | Austrittsöffnung orifice size | Dichtung seal | Originalitätsverschluss tamper evidence | Kindersicherung child resistance | Entgasung venting device |
|----------------------------|---|---------------------------------------|---------------------------------|-----------------------------|----------------------------------|------------------|--|-------------------------------------|-----------------------------|
| 35208..1 | PP | PP | Schraubversion screw version | 28 / 410 | 4 mm | Konus cone | - | - | - |

KIPPHEBEL-SCHRAUBVERSCHLÜSSE // TURRET SCREW CAPS

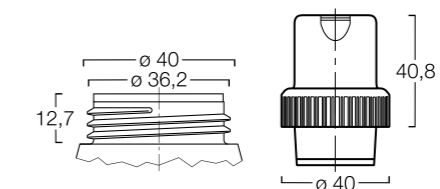

| Artikel-Nr. article no. | Material Verschluss material closure | Material Kipphebel material turret | Anbringungsart fixing type | Gewindegröße thread size | Austrittsöffnung orifice size | Dichtung seal | Originalitätsverschluss tamper evidence | Kindersicherung child resistance | Entgasung venting device |
|----------------------------|---|---------------------------------------|---------------------------------|-----------------------------|----------------------------------|------------------|--|-------------------------------------|-----------------------------|
| 52127..1 | PP | PP | Schraubversion screw version | 36 mm | 4 mm | Konus cone | - | - | - |

VERSCHLÜSSE FÜR TUBEN // TUBE CLOSURES



Ø 38 mm mit konturbündigem Schamier.
Für 40er-Tube
Ø 38 mm hinge with a flush profile.
For tube with diameter 40

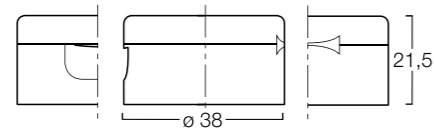

| Artikel-Nr. article no. | Material material | Anbringungsart fixing type | Gewindegröße thread size | Ø Austrittsöffnung Ø orifice size | Dichtung seal | Oberfläche surface | Drehrichtung direction for turning |
|----------------------------|----------------------|---------------------------------|-----------------------------|--------------------------------------|------------------|-----------------------|---------------------------------------|
| 11757..1 | PP | Schraubversion screw version | M 15 x 1,5 | 4 mm | Konus cone | glatt polished | - |
| 11757..2 | PP | Schraubversion screw version | M 15 x 1,5 | 5 mm | Konus cone | glatt polished | - |
| 11757..3 | PP | Schraubversion screw version | M 15 x 1,5 | 3 mm | Konus cone | glatt polished | - |

VERSCHLÜSSE FÜR TUBEN // TUBE CLOSURES



Ø 48 mm. Für 50er-Tuben
Ø 48 mm. For tube with diameter 50

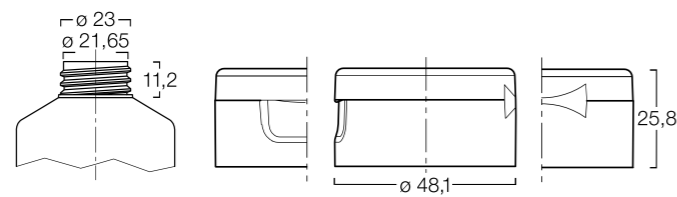

| Artikel-Nr. article no. | Material material | Anbringungsart fixing type | Gewindegröße thread size | Ø Austrittsöffnung Ø orifice size | Dichtung seal | Oberfläche surface | Drehrichtung direction for turning |
|----------------------------|----------------------|---------------------------------|-----------------------------|--------------------------------------|------------------|-----------------------|---------------------------------------|
| 52067..1 | PP | Schraubversion screw version | M 22 x 3 | 6 mm | Konus cone | glatt polished | - |
| 52067..2 | PP | Schraubversion screw version | M 22 x 3 | 5 mm | Konus cone | glatt polished | - |
| 52067..3 | PP | Schraubversion screw version | M 22 x 3 | 4 mm | Konus cone | glatt polished | - |
| 52067..4 | PP | Schraubversion screw version | M 22 x 3 | 3 mm | Konus cone | glatt polished | - |

VERSCHLÜSSE FÜR TUBEN // TUBE CLOSURES



Ø 48 mm. Für 50er-Tuben
Ø 48 mm. For tube with diameter 50

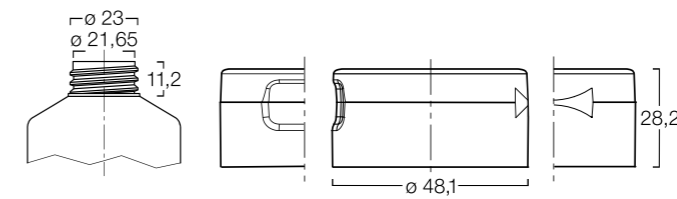

| Artikel-Nr. article no. | Material material | Anbringungsart fixing type | Gewindegröße thread size | Ø Austrittsöffnung Ø orifice size | Dichtung seal | Oberfläche surface | Drehrichtung direction for turning |
|----------------------------|----------------------|---------------------------------|-----------------------------|--------------------------------------|------------------|-----------------------|---------------------------------------|
| 13033..1 | PP | Schraubversion screw version | M 22 x 3 | 4 mm | Konus cone | glatt polished | - |
| 13033..2 | PP | Schraubversion screw version | M 22 x 3 | 3 mm | Konus cone | glatt polished | - |
| 13033..3 | PP | Schraubversion screw version | M 22 x 3 | 6 mm | Konus cone | glatt polished | - |

VERSCHLÜSSE FÜR TUBEN // TUBE CLOSURES



Ø 48 mm. Für 50er-Tuben
Ø 48 mm. For tube with diameter 50

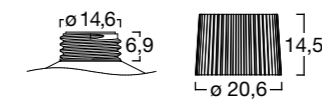

| Artikel-Nr. article no. | Material material | Anbringungsart fixing type | Gewindegröße thread size | Ø Austrittsöffnung Ø orifice size | Dichtung seal | Oberfläche surface | Drehrichtung direction for turning |
|----------------------------|----------------------|---------------------------------|-----------------------------|--------------------------------------|------------------|-----------------------|---------------------------------------|
| 12518..1 | PE | Schraubversion screw version | M 15 x 1,5 | - | Konus cone | geriffelt ribbed | - |

SCHWAMMAUFTRÄGER FÜR PASTÖSE FÜLLGÜTER // SPONGE APPLICATORS FOR VISCOUS FILLINGS

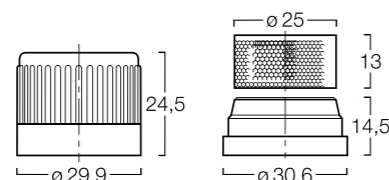

Für 30er-Tube
for tube with diameter 30

| Artikel-Nr. article no. | Material Oberteil material upper part | Material Unterteil material base | Gewindegröße thread size | Drehrichtung thread direction | Austrittsöffnung orifice size | Dichtung seal |
|----------------------------|--|-------------------------------------|-----------------------------|----------------------------------|---|------------------|
| 51019.A | PP | PE | M 12 x 1,25 | rechts right | Schwamm mit mittigem Loch sponge with hole in the middle | Konus cone |
| 51019.B | PP | PE | M 12 x 1,25 | links left | Schwamm mit mittigem Loch sponge with hole in the middle | Konus cone |

SCHWAMMAUFTRÄGER FÜR PASTÖSE FÜLLGÜTER // SPONGE APPLICATORS FOR VISCOUS FILLINGS

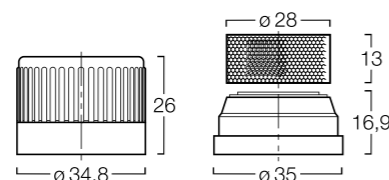

Für 35er-Tube
for tube with diameter 35

| Artikel-Nr. article no. | Material Oberteil material upper part | Material Unterteil material base | Gewindegröße thread size | Drehrichtung thread direction | Austrittsöffnung orifice size | Dichtung seal |
|----------------------------|--|-------------------------------------|-----------------------------|----------------------------------|---|------------------|
| 51024.A | PP | PE | M 11 x 1,25 | rechts right | Schwamm mit mittigem Loch sponge with hole in the middle | Konus cone |
| 51024.B | PP | PE | M 15 x 1,5 | rechts right | Schwamm mit mittigem Loch sponge with hole in the middle | Konus cone |
| 51024.C | PP | PE | M 11 x 1,5 | links left | Schwamm mit mittigem Loch sponge with hole in the middle | Konus cone |

SCHWAMMAUFTRÄGER FÜR PASTÖSE FÜLLGÜTER // SPONGE APPLICATORS FOR VISCOUS FILLINGS

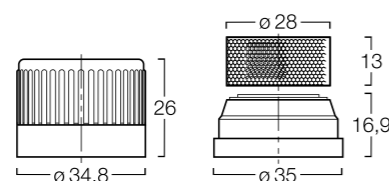

Für Flasche
for bottle

| Artikel-Nr. article no. | Material Oberteil material upper part | Material Unterteil material base | Gewindegröße thread size | Drehrichtung thread direction | Austrittsöffnung orifice size | Dichtung seal |
|----------------------------|--|-------------------------------------|-----------------------------|----------------------------------|---|------------------|
| 51024.D | PP | PE | 26,7 mm | - | Schwamm mit mittigem Loch sponge with hole in the middle | Konus cone |
| 51024.E* | PP | PE | 26,7 mm | - | Schwamm mit mittigem Loch sponge with hole in the middle | Konus cone |

*Verfügbar als Prellversion
*Available as push-on version

SCHWAMMAUFTRÄGER FÜR PASTÖSE FÜLLGÜTER // SPONGE APPLICATORS FOR VISCOUS FILLINGS



Handaufträger
hand applicator

Ausführliche Artikelbeschreibung siehe Seite 41
Details about this article see page 41

Verpackung Kit A42
Packaging Kit A42

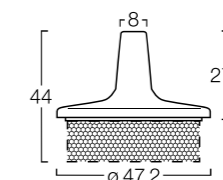

| Artikel-Nr. article no. | Version | Material Basis material basis | Artikelbezeichnung article description | Ventil Standard valve standard | Ventil kurz valve short | Ø Austrittsöffnung Ø orifice size | Schaumstofftyp sponge type |
|----------------------------|---------|----------------------------------|---|-----------------------------------|----------------------------|--------------------------------------|-------------------------------|
| 51021.A | A42 | PP | Handapplikator hand applicator | - | - | - | V-65 |
| 52058.A | A42 | PP | Deckel lid | - | - | - | - |
| 76005.A | A42 | Glas glass | Tiegel jar | - | - | - | - |
| 81011.A | A42 | PP | Kit kit | - | - | - | V-65 |

SCHWAMMAUFTRÄGER FÜR FLÜSSIGE FÜLLGÜTER // SPONGE APPLICATORS FOR LIQUID FILLINGS

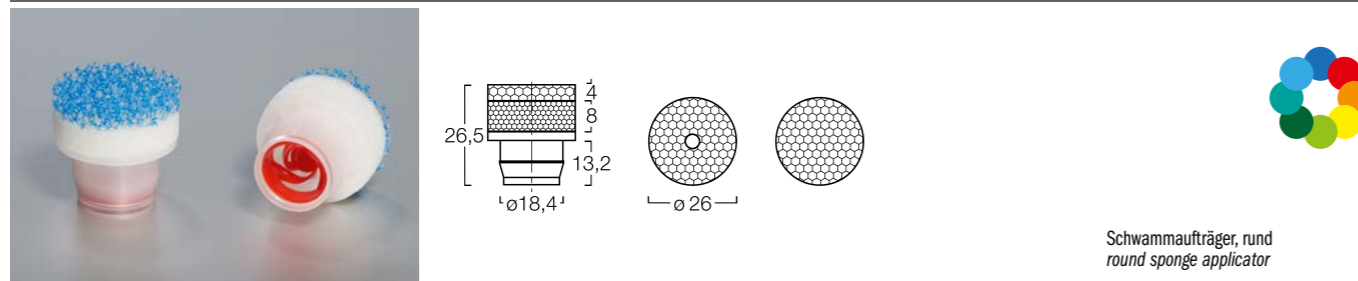

Schwammpuffer, rund
round sponge applicator

| Artikel-Nr. article no. | Version version | Material Basis material basis | Material Ventil material valve | Ventil Standard valve standard | Ventil kurz valve short | Ø Austrittsöffnung Ø orifice size | Schaumstofftyp sponge type |
|----------------------------|--------------------|----------------------------------|-----------------------------------|-----------------------------------|----------------------------|---|-------------------------------|
| 51015.G | A1 | LDPE | LDPE | ■ | - | Schwamm mit mittigem Loch sponge with hole in the middle | V-8 + PPI-20 |
| 51015.H | A1 | LDPE | LDPE | - | ■ | Schwamm ohne mittiges Loch sponge without hole in the middle | V-8 + PPI-20 |

SCHWAMMAUFTRÄGER FÜR FLÜSSIGE FÜLLGÜTER // SPONGE APPLICATORS FOR LIQUID FILLINGS

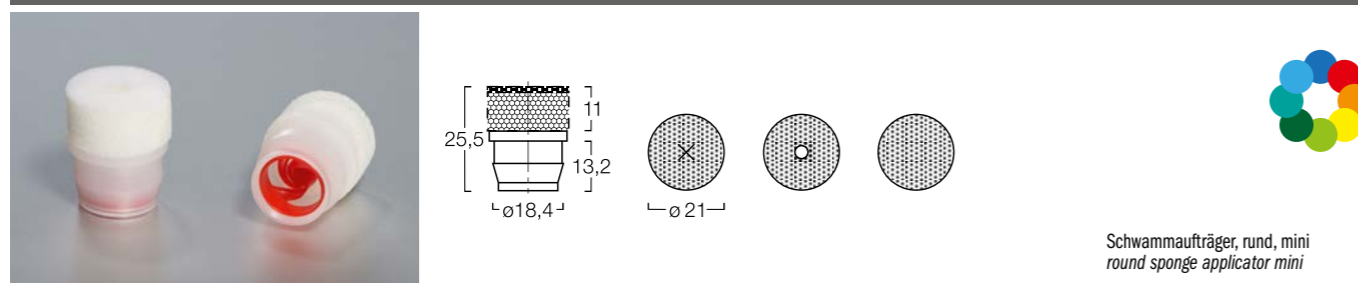

Schwammpuffer, rund, mini
round sponge applicator mini

| Artikel-Nr. article no. | Version version | Material Basis material basis | Material Ventil material valve | Ventil Standard valve standard | Ventil kurz valve short | Ø Austrittsöffnung Ø orifice size | Schaumstofftyp sponge type |
|----------------------------|--------------------|----------------------------------|-----------------------------------|-----------------------------------|----------------------------|--|-------------------------------|
| 51005.A | A5 | LDPE | LDPE | ■ | - | Schwamm mit Kreuzschlitz, mittig sponge with cross slot in the middle | V-65 |
| 51005.B | A5 | LDPE | LDPE | ■ | - | Schwamm mit mittigem Loch sponge with hole in the middle | V-65 |
| 51005.C | A5 | LDPE | LDPE | - | ■ | Schwamm ohne mittiges Loch sponge without hole in the middle | V-65 |

SCHWAMMAUFTRÄGER FÜR FLÜSSIGE FÜLLGÜTER // SPONGE APPLICATORS FOR LIQUID FILLINGS

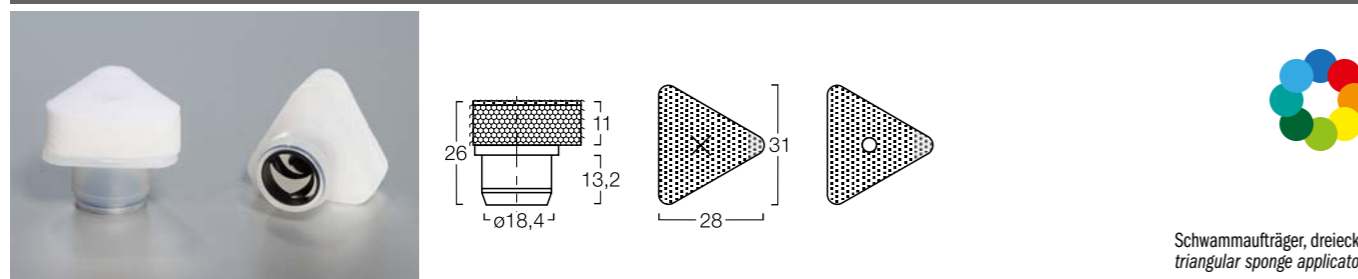

Schwammpuffer, dreieckig
triangular sponge applicator

| Artikel-Nr. article no. | Version version | Material Basis material basis | Material Ventil material valve | Ventil Standard valve standard | Ventil kurz valve short | Ø Austrittsöffnung Ø orifice size | Schaumstofftyp sponge type |
|----------------------------|--------------------|----------------------------------|-----------------------------------|-----------------------------------|----------------------------|--|-------------------------------|
| 71011.A | A4 | LDPE | LDPE | ■ | - | Schwamm mit Kreuzschlitz, mittig sponge with cross slot in the middle | V-65 |
| 71011.B | A4 | LDPE | LDPE | ■ | - | Schwamm mit mittigem Loch sponge with hole in the middle | V-8 |

SCHWAMMAUFTRÄGER FÜR FLÜSSIGE FÜLLGÜTER // SPONGE APPLICATORS FOR LIQUID FILLINGS

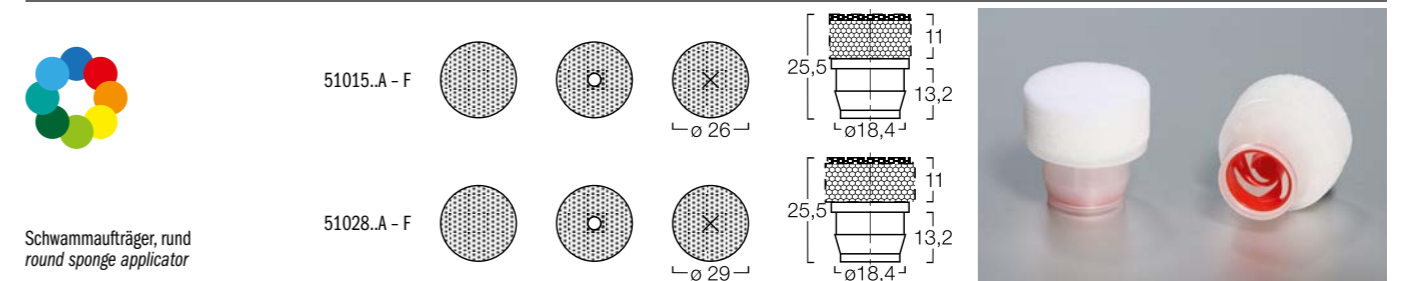

Schwammpuffer, rund
round sponge applicator

| Artikel-Nr. article no. | Version version | Material Basis material basis | Material Ventil material valve | Ventil Standard valve standard | Ventil kurz valve short | Ø Austrittsöffnung Ø orifice size | Schaumstofftyp sponge type |
|----------------------------|--------------------|----------------------------------|-----------------------------------|-----------------------------------|----------------------------|--|-------------------------------|
| 51015.A | A1 | LDPE | LDPE | ■ | - | Schwamm mit Kreuzschlitz, mittig sponge with cross slot in the middle | V-65 |
| 51015.B | A1 | LDPE | LDPE | ■ | - | Schwamm mit mittigem Loch sponge with hole in the middle | V-65 |
| 51015.C | A1 | LDPE | LDPE | - | ■ | Schwamm ohne mittiges Loch sponge without hole in the middle | V-65 |
| 51015.D | A1 | LDPE | LDPE | ■ | - | Schwamm mit Kreuzschlitz, mittig sponge with cross slot in the middle | V-8 |
| 51015.E | A1 | LDPE | LDPE | ■ | - | Schwamm mit mittigem Loch sponge with hole in the middle | V-8 |
| 51015.F | A1 | LDPE | LDPE | - | ■ | Schwamm ohne mittiges Loch sponge without hole in the middle | V-8 |
| 51028.A | A1 | LDPE | LDPE | ■ | - | Schwamm mit Kreuzschlitz, mittig sponge with cross slot in the middle | V-65 |
| 51028.B | A1 | LDPE | LDPE | ■ | - | Schwamm mit mittigem Loch sponge with hole in the middle | V-65 |
| 51028.C | A1 | LDPE | LDPE | - | ■ | Schwamm ohne mittiges Loch sponge without hole in the middle | V-65 |
| 51028.D | A1 | LDPE | LDPE | ■ | - | Schwamm mit Kreuzschlitz, mittig sponge with cross slot in the middle | V-8 |
| 51028.E | A1 | LDPE | LDPE | ■ | - | Schwamm mit mittigem Loch sponge with hole in the middle | V-8 |
| 51028.F | A1 | LDPE | LDPE | - | ■ | Schwamm ohne mittiges Loch sponge without hole in the middle | V-8 |

TECHNISCHE EIGENSCHAFTEN DER SCHWÄMME „PUR“ // TECHNICAL CHARACTERISTICS OF "PUR" MENSHEN SPONGES

| Schaumstofftyp sponge type | Rohdichte density DIN 53 420 | Stauchhärte compr. resist. DIN 53 577 | Zugfestigkeit traction resist. DIN 53 571 | Bruchdehnung elasticity limit DIN 53 571 | Resid. Verform. resid. deform. DIN 53 572 | Aussehen appearance | Farbe color |
|-------------------------------|------------------------------------|---|---|--|---|------------------------|-------------------------|
| V-8 | 45 kg/m ³ | 15 kPa | 450 kPa | 380 % | 11 % | fein fine | Weiß white |
| D-55 (V-55) | 55 kg/m ³ | 5,5 kPa | > 200 kPa | > 250 % | > 5 % | - | - |
| PE closed cell (BC) | 60 kg/m ³ | 80 kPa | 0,69 kPa | 140 % | - | - | - |
| V-65 | 45 kg/m ³ | 11 kPa | 410 kPa | 390 % | 9 % | fein fine | Weiß white |
| PPI-20 | 20 - 24 kg/m ³ | 3 - 5 kPa | < 80 kPa | < 100 % | 5 % | grob coarse | Blau blue |
| Polyester D-25 | 25 kg/m ³ | 3,7 - 4,7 kPa | > 160 kPa | > 120 % | > 10 % | fein fine | Weiß-Grau white-grey |

BEI BESTELLUNG BITTE ANGEBEN // IN CASE OF ORDER PLEASE STATE

Wenn nichts Gegenteiliges erwähnt ist, werden alle Schwammaufträger mit Flock geliefert.
Alle Schwammaufträger sind auch ohne Flock lieferbar.

*If not otherwise mentioned, all applicators are supplied flocked.
All Sponge Applicators are deliverable as well without flock.*

OHNE FLOCK // WITHOUT FLOCK

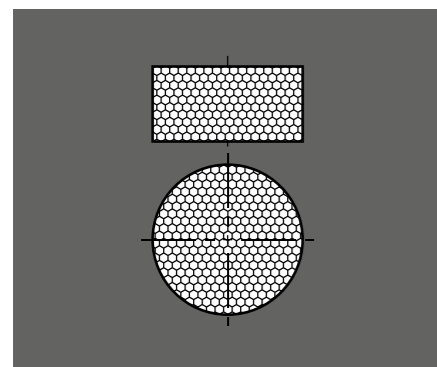

MIT FLOCK // WITH FLOCK

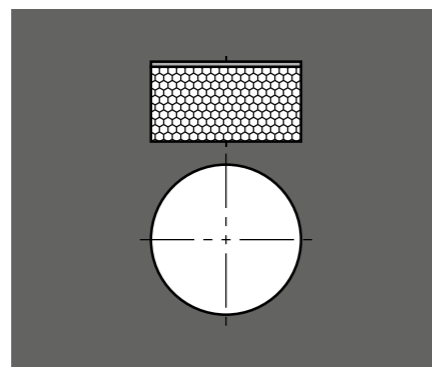

ZWEISCHICHTIG // DOUBLE LAYER

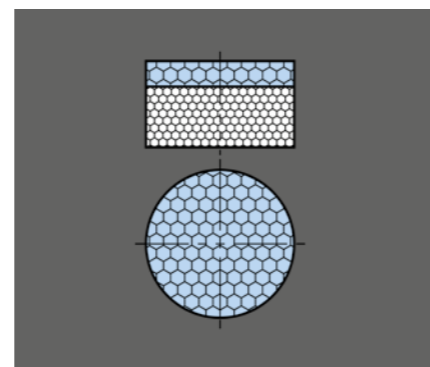

DOSIER-SCHWAMMAUFTRÄGER PAD // DOSING APPLICATOR PAD

Produktkomponenten:

- 15-ml-Flasche (Artikel-Nr. 76002)
- Dosierpumpe (0,075 ml) (Artikel-Nr. 74001)
- Schwammaufträger (Artikel-Nr. 51008)
- transparente Kappe (Artikel-Nr. 52002)

Product Components:

- 15 ml bottle (article no. 76002)
- dosing pump (dosage 0,075 ml) (article no. 74001)
- sponge applicator (article no. 51008)
- transparent cap (article no. 52002)

Anwendungsbereiche:

- Optik
- Informatik
- Audio/Video
- Dermatologie
- Pharma
- Veterinärmedizin
- Kosmetik
- Malerei

Applications:

- optics
- informatics
- audio-video
- dermatology
- pharmacy
- animal care
- cosmetics
- painting



SCHWAMMAUFTRÄGER PLC // SPONGE APPLICATOR PLC

Produktkomponenten:

- 100-ml-Flasche (Artikel-Nr. 76001)
- 50-ml-Flasche (Artikel-Nr. 76017)
- Schwammaufträger (Artikel-Nr. 51015)
- Kappe (Artikel-Nr. 52001)

Product Components:

- 100 ml bottle (article no. 76001)
- 50 ml bottle (article no. 76017)
- sponge applicator (article no. 51015)
- cap (article no. 52001)

Anwendungsbereiche:

- Schuhpflege
- Färbungen
- Leime
- Landwirtschaft
- Haushalt
- Wachse
- Veterinärmedizin

Applications:

- shoe polisher
- coloring
- glue
- agriculture
- household
- wax
- animal care



Flasche lieferbar in Schwarz oder Weiß. Kappe lieferbar in Schwarz, Weiß, Blau, Braun oder Transparent.

Bottle available in black or white. Cap available in black, white, blue, brown or transparent.

VERPACKUNG KIT A42 // PACKAGING KIT A42

Produktkomponenten:

- Glastiegel 50 cc
- Kappe mit Schwammhalterung und innenliegender Aluminium-Einlage, Hand-Schwamm-aufträger A42

Product Components:

- glass jar 50 cc
- cap with holder for applicator and internal aluminium liner, hand applicator A42

Anwendungsbereiche:

- Lederpflege
- Skiwachs
- Schuhpflege

Applications:

- leather care
- ski waxing
- shoe polish



in PCR Material verfügbar

available in PCR material

VERSCHLUSSKAPPE // CAP

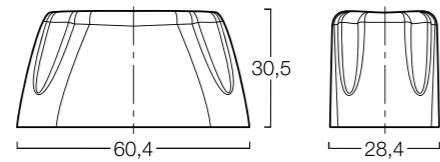

Passend zu Spritzer Art.-Nr. 12160..1
to combine with plug article no. 12160..1

| Artikel-Nr. article no. | Material Verschluss material closure | Anbringungsart fixing type | Gewindegröße thread size | Dosiervolumen dosage volume | Dichtung seal | Kindersicherung child resistance | Entgasung venting device |
|----------------------------|---|---------------------------------|-----------------------------|--------------------------------|------------------|-------------------------------------|-----------------------------|
| 12159..1 | PP | Prellversion push on version | - | - | Dorn spigot | - | - |

SPRITZER // PLUG

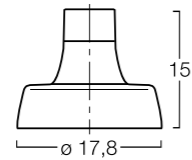

Spritzer, nicht montiert, passend zu Verschluss
Art.-Nr. 12159..1
plug, unassembled, to combine with cap article
no. 12159..1

| Artikel-Nr. article no. | Material Spritzer material plug | Anbringungsart fixing type | Gewindegröße thread size | Ø Austrittsöffnung Ø orifice size | Dichtung seal | Kindersicherung child resistance | Entgasung venting device |
|----------------------------|------------------------------------|---------------------------------|-----------------------------|--------------------------------------|------------------|-------------------------------------|-----------------------------|
| 12160..1 | PE | Prellversion push on version | - | 4 mm | Konus cone | - | - |



2

Weldspouts für flexible Verpackungen *Weldspouts for flexible packaging*

Vor Ort für Sie.

Starke globale Präsenz zur Lieferung lokaler Lösungen. Angebot einer umfassenden Auswahl an Standard-Weldspouts und kundenspezifischen Weldspout-Lösungen für eine Vielfalt an Produktanwendungen, sowohl für die Befüllung durch das Einschweißsteil als auch durch die Kopfnahm des Beutels.

Unabhängig.

Intensive Zusammenarbeit entlang der Wertschöpfungskette zur Lieferung der optimalen individuellen Lösung. Entwicklung von kompletten Verpackungslösungen sowie Lieferung von marktgerechten Innovationen.

Expertise.

Ihnen steht ein breit aufgestelltes Experten-Team zur Umsetzung technischer und wirtschaftlicher Marktanforderungen zur Verfügung. Lieferung von Produkten auf höchstem Qualitätsniveau, die strengen Funktions- und Sicherheitsstandards entsprechen.

MENSHEN.

Ihr Partner in der Welt der Weldspouts.

Local.

Leveraging our global presence to deliver local solutions. Offering a comprehensive range of standard and customized weldspouts for a variety of product applications, either filled through the spout or through the pouch.

Independent.

Collaborating with partners across the supply chain to deliver optimal solutions. Developing total package solutions and delivering commercially-ready innovations.

Expertise.

A multi-disciplinary team, dedicated to meet technical and commercial market needs, is on-hand to support you. Delivering high-quality products that meet stringent functionality & safety requirements.

MENSHEN.

Your partner in the world of weldspouts.

FÜLLUNG DURCH DEN BEUTEL // FILLING THROUGH POUCH

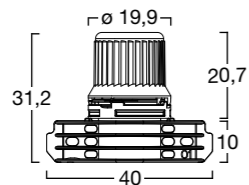

Light Weight Spout-A

| Artikel-Nr. article no. | Produktionsstandort production site | Material ESWT material spout | Material Verschluss material cap | Ø Austrittsöffnung Ø orifice size | Originalitätsverschluss tamper evidence |
|----------------------------|--|---------------------------------|-------------------------------------|--------------------------------------|--|
| 38575.4 | DE | PE | PE | 11 mm | ■ |
| 38575.2 | CN | PE | PE | 11 mm | ■ |

FÜLLUNG DURCH DEN BEUTEL // FILLING THROUGH POUCH

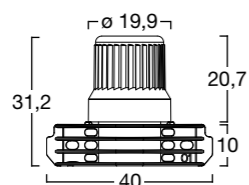

Light Weight Spout-A

| Artikel-Nr. article no. | Produktionsstandort production site | Material ESWT material spout | Material Verschluss material cap | Ø Austrittsöffnung Ø orifice size | Originalitätsverschluss tamper evidence |
|----------------------------|--|---------------------------------|-------------------------------------|--------------------------------------|--|
| 38583.2 | DE | PE | PE | 11 mm | - |

FÜLLUNG DURCH DEN BEUTEL // FILLING THROUGH POUCH

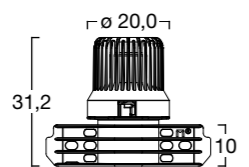

Hemera

| Artikel-Nr. article no. | Produktionsstandort production site | Material ESWT material spout | Material Verschluss material cap | Ø Austrittsöffnung Ø orifice size | Originalitätsverschluss tamper evidence |
|----------------------------|--|---------------------------------|-------------------------------------|--------------------------------------|--|
| 38586.1 | DE | PE | PE | 11 mm | ■ |
| 38587.1 | DE | PP | PP | 11 mm | ■ |
| 38593.1 | DE | PE low melting | PE | 11 mm | ■ |
| 38594.1 | DE | PP low melting | PP | 11 mm | ■ |

FÜLLUNG DURCH DEN BEUTEL // FILLING THROUGH POUCH

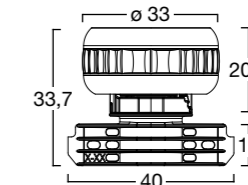

Choke Safe Cap-A Trunk Wheel

| Artikel-Nr. article no. | Produktionsstandort production site | Material ESWT material spout | Material Verschluss material cap | Ø Austrittsöffnung Ø orifice size | Originalitätsverschluss tamper evidence |
|----------------------------|--|---------------------------------|-------------------------------------|--------------------------------------|--|
| 55004.1 | ES | PE/PP | PP | 9,5 mm | ■ |
| 638514.1 | US | PE | PP | 9,5 mm | ■ |
| 638514.2 | US | PP | PP | 9,5 mm | ■ |

FÜLLUNG DURCH DEN BEUTEL // FILLING THROUGH POUCH

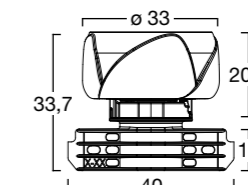

Choke Safe Cap-A Twisted Leaves

| Artikel-Nr. article no. | Produktionsstandort production site | Material ESWT material spout | Material Verschluss material cap | Ø Austrittsöffnung Ø orifice size | Originalitätsverschluss tamper evidence |
|----------------------------|--|---------------------------------|-------------------------------------|--------------------------------------|--|
| 38521.1 | DE | PE/PP | PP | 9,5 mm | ■ |

FÜLLUNG DURCH DEN BEUTEL // FILLING THROUGH POUCH

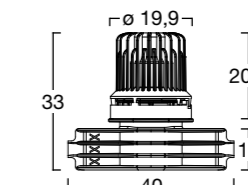

Fruity

| Artikel-Nr. article no. | Produktionsstandort production site | Material ESWT material spout | Material Verschluss material cap | Ø Austrittsöffnung Ø orifice size | Originalitätsverschluss tamper evidence |
|----------------------------|--|---------------------------------|-------------------------------------|--------------------------------------|--|
| 38561..9 | DE | PE | PE | 8,5 mm | ■ |

FÜLLUNG DURCH DEN BEUTEL // FILLING THROUGH POUCH

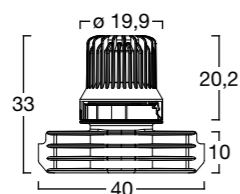

Apple Safe

| Artikel-Nr. article no. | Produktionsstandort production site | Material ESWT material spout | Material Verschluss material cap | Ø Austrittsöffnung Ø orifice size | Originalitätsverschluss tamper evidence |
|----------------------------|--|---------------------------------|-------------------------------------|--------------------------------------|--|
| 38569..1 | DE | PE | PE | 8,5 mm | ■ |

FÜLLUNG DURCH DEN BEUTEL // FILLING THROUGH POUCH

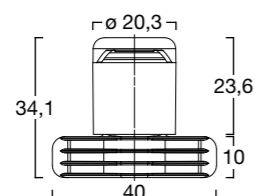

| Artikel-Nr. article no. | Produktionsstandort production site | Material ESWT material spout | Material Verschluss material cap | Ø Austrittsöffnung Ø orifice size | Originalitätsverschluss tamper evidence |
|----------------------------|--|---------------------------------|-------------------------------------|--------------------------------------|--|
| 38525..1 | DE | PE | PP | 4 mm | - |

FÜLLUNG DURCH DEN BEUTEL // FILLING THROUGH POUCH

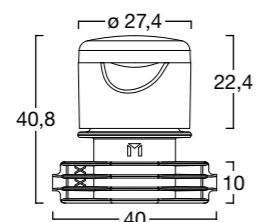

| Artikel-Nr. article no. | Produktionsstandort production site | Material ESWT material spout | Material Verschluss material cap | Ø Austrittsöffnung Ø orifice size | Originalitätsverschluss tamper evidence |
|----------------------------|--|---------------------------------|-------------------------------------|--------------------------------------|--|
| 38573..1 | DE | PE | PP | 1,5; 3; 4,4 mm | - |

FÜLLUNG DURCH DEN BEUTEL // FILLING THROUGH POUCH

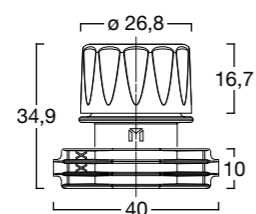

| Artikel-Nr. article no. | Produktionsstandort production site | Material ESWT material spout | Material Verschluss material cap | Ø Austrittsöffnung Ø orifice size | Originalitätsverschluss tamper evidence |
|----------------------------|--|---------------------------------|-------------------------------------|--------------------------------------|--|
| 38556..1 | DE | PE | PP | 19 mm | - |

FÜLLUNG DURCH DEN BEUTEL // FILLING THROUGH POUCH

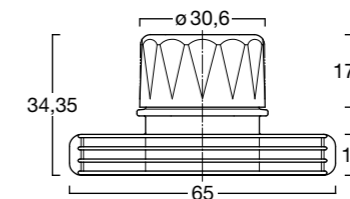

| Artikel-Nr. article no. | Produktionsstandort production site | Material ESWT material spout | Material Verschluss material cap | Ø Austrittsöffnung Ø orifice size | Originalitätsverschluss tamper evidence |
|----------------------------|--|---------------------------------|-------------------------------------|--------------------------------------|--|
| 38515..1 | DE | PE | PP | 21 mm | - |

FÜLLUNG DURCH DEN BEUTEL // FILLING THROUGH POUCH

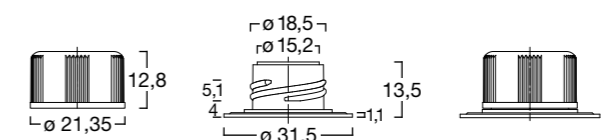

Front Valve

| Artikel-Nr. article no. | Produktionsstandort production site | Material ESWT material spout | Material Verschluss material cap | Ø Austrittsöffnung Ø orifice size | Originalitätsverschluss tamper evidence |
|----------------------------|--|---------------------------------|-------------------------------------|--------------------------------------|--|
| 601510 | MX | PE | PE | 11 mm | ■ |

FÜLLUNG DURCH DEN BEUTEL // FILLING THROUGH POUCH

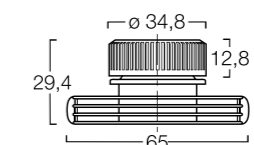

Mit und ohne ALU Liner erhältlich
available with and without ALU Liner

| Artikel-Nr. article no. | Produktionsstandort production site | Material ESWT material spout | Material Verschluss material cap | Ø Austrittsöffnung Ø orifice size | Originalitätsverschluss tamper evidence |
|----------------------------|--|---------------------------------|-------------------------------------|--------------------------------------|--|
| 38506..1 | DE | PE | PP | 25 mm | - |
| 38506..2 | DE | PE/PP | PP | 25 mm | ■ |

FÜLLUNG DURCH DEN BEUTEL // FILLING THROUGH POUCH

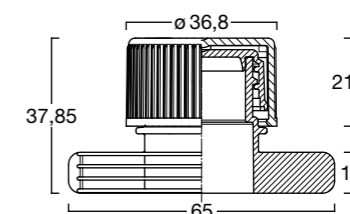

Geeignet für kindergesicherte Verpackungen
suitable for child resistant packaging

| Artikel-Nr. article no. | Produktionsstandort production site | Material ESWT material spout | Material Verschluss material cap | Ø Austrittsöffnung Ø orifice size | Originalitätsverschluss tamper evidence |
|----------------------------|--|---------------------------------|-------------------------------------|--------------------------------------|--|
| 38555..1 | DE | PE | PP | 21 mm | - |

FÜLLUNG DURCH DEN BEUTEL // FILLING THROUGH POUCH

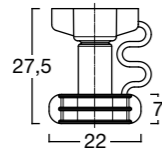

Mit wiederverschließbarer Abbrechkappe
with reclosable break-off cap

| Artikel-Nr. article no. | Produktionsstandort production site | Material ESWT material spout | Material Verschluss material cap | Ø Austrittsöffnung Ø orifice size | Originalitätsverschluss tamper evidence |
|----------------------------|--|---------------------------------|-------------------------------------|--------------------------------------|--|
| 12994..1 | DE | PE | - | 6,5 mm | ■ |

FÜLLUNG DURCH DEN WELDSPOUT // FILLING THROUGH WELDSPOUT

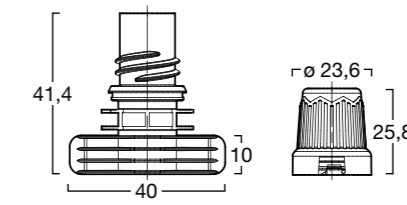

Smart Break

| Artikel-Nr. article no. | Produktionsstandort production site | Material ESWT material spout | Material Verschluss material cap | Ø Austrittsöffnung Ø orifice size | Originalitätsverschluss tamper evidence |
|----------------------------|--|---------------------------------|-------------------------------------|--------------------------------------|--|
| WELDSPOUT // WELDSPOUT | | | | | |
| 12463..1 | DE | PE | - | 12,5 mm | - |
| VERSCHLUSS // CAP | | | | | |
| 12464..1 | DE | - | PP | - | ■ |

FÜLLUNG DURCH DEN WELDSPOUT // FILLING THROUGH WELDSPOUT

Vormontiert
preassembled

Mit Originalität für aseptische Abfüllung
with tamper evidence for aseptic filling

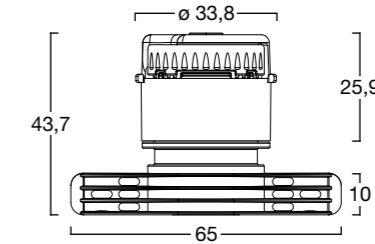

| Artikel-Nr. article no. | Produktionsstandort production site | Material ESWT material spout | Material Verschluss material cap | Ø Austrittsöffnung Ø orifice size | Originalitätsverschluss tamper evidence |
|----------------------------|--|---------------------------------|-------------------------------------|--------------------------------------|--|
| 38585..1 | DE | PE | PP | 11,6 mm | ■ |

FÜLLUNG DURCH DEN WELD SPOUT // FILLING THROUGH WELD SPOUT

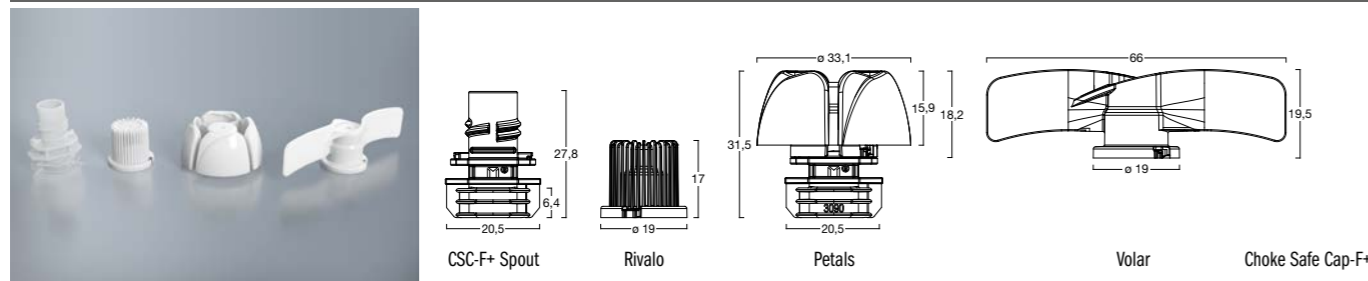

| Artikel-Nr. article no. | Produktionsstandort production site | Material ESWT material spout | Material Verschluss material cap | Ø Austrittsöffnung Ø orifice size | Originalitätsverschluss tamper evidence |
|--|--|---------------------------------|-------------------------------------|--------------------------------------|--|
| WELD SPOUT // WELD SPOUT – CSC-F+ SPOUT | | | | | |
| 13090..1 | DE | PE/PP | - | 8,5 mm | - |
| VERSCHLUSS // CAP – RIVALO | | | | | |
| 13091..1 | DE | - | PE/PP | - | ■ |
| VERSCHLUSSSICHERER VERSCHLUSS // CHOKE SAFE CAP – PETALS | | | | | |
| 55008 | ES | - | PE/PP | - | ■ |
| VERSCHLUSSSICHERER VERSCHLUSS // CHOKE SAFE CAP – VOLAR | | | | | |
| 13092..1 | DE | - | PE/PP | - | ■ |

FÜLLUNG DURCH DEN WELD SPOUT // FILLING THROUGH WELD SPOUT

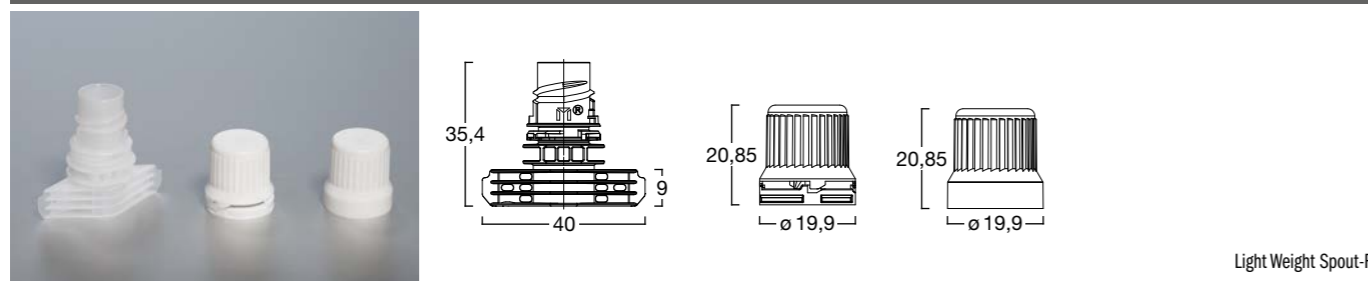

| Artikel-Nr. article no. | Produktionsstandort production site | Material ESWT material spout | Material Verschluss material cap | Ø Austrittsöffnung Ø orifice size | Originalitätsverschluss tamper evidence |
|---|--|---------------------------------|-------------------------------------|--------------------------------------|--|
| WELD SPOUT // WELD SPOUT | | | | | |
| 12813..1 | DE | PE | - | 11 mm | - |
| VERSCHLUSS MIT ORIGINALITÄT // CAP WITH TAMPER EVIDENCE | | | | | |
| 12982..1 | DE | - | PE | - | ■ |
| VERSCHLUSS // CAP | | | | | |
| 12983..1 | DE | - | PE | - | - |

FÜLLUNG DURCH DEN BEUTEL UND DEN WELD SPOUT // FILLING THROUGH POUCH AND WELD SPOUT

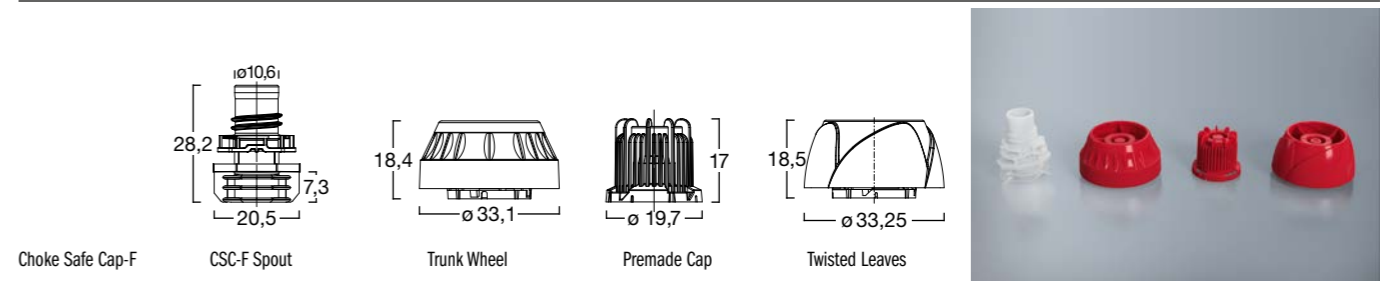

| Artikel-Nr. article no. | Produktionsstandort production site | Material ESWT material spout | Material Verschluss material cap | Ø Austrittsöffnung Ø orifice size | Originalitätsverschluss tamper evidence |
|--|--|---------------------------------|-------------------------------------|--------------------------------------|--|
| WELD SPOUT // WELD SPOUT – CSC-F SPOUT | | | | | |
| 612959..2 | US | PE | - | 8,5 mm | - |
| 612959..5 | US | PP | - | 8,5 mm | - |
| WSF07500 1000123 | MX | PP/PE | - | 8,5 mm | - |
| 46013019017 | RU | PE | - | 8,5 mm | - |
| VERSCHLUSSSICHERER VERSCHLUSS // CHOKE SAFE CAP – TRUNK WHEEL | | | | | |
| SF07500 1000XXX | MX | - | PP/PE | - | ■ |
| VERSCHLUSS // CAP – Premade Cap | | | | | |
| 55006..1 | ES | - | PP | - | ■ |
| VERSCHLUSSSICHERER VERSCHLUSS // CHOKE SAFE CAP – TWISTED LEAVES | | | | | |
| WSF07500 1000XXTL | MX | - | PP/PE | - | ■ |
| 460130741 | RU | - | PP | - | ■ |

FÜLLUNG DURCH DEN BEUTEL UND DEN WELD SPOUT // FILLING THROUGH POUCH AND WELD SPOUT

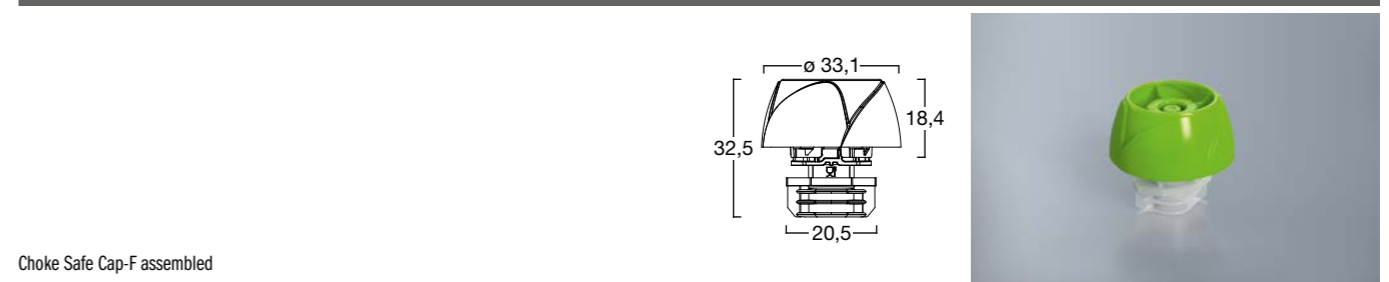

| Artikel-Nr. article no. | Produktionsstandort production site | Material ESWT material spout | Material Verschluss material cap | Ø Austrittsöffnung Ø orifice size | Originalitätsverschluss tamper evidence |
|----------------------------|--|---------------------------------|-------------------------------------|--------------------------------------|--|
| 46039253008 | RU | PE | PP | 8,5 mm | ■ |

FÜLLUNG DURCH DEN BEUTEL UND DEN WELDSPOUT // FILLING THROUGH POUCH AND WELDPOUT

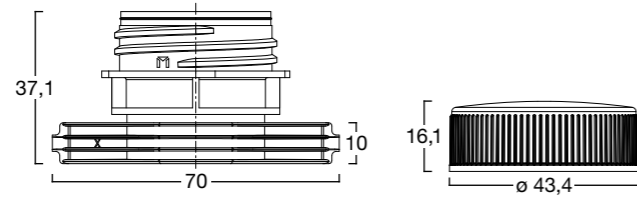

| Artikel-Nr. article no. | Produktionsstandort production site | Material ESWT material spout | Material Verschluss material cap | Ø Austrittsöffnung Ø orifice size | Originalitätsverschluss tamper evidence |
|----------------------------|--|---------------------------------|-------------------------------------|--------------------------------------|--|
| WELDSPOUT // WELDPOUT | | | | | |
| 12606..1 | DE | PE | - | 34 mm | - |
| VERSCHLUSS // CAP | | | | | |
| 12607..1 | DE | - | PP | - | - |

FÜLLUNG DURCH DEN BEUTEL UND DEN WELDSPOUT // FILLING THROUGH POUCH AND WELDPOUT

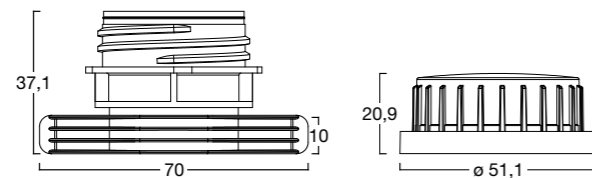

| Artikel-Nr. article no. | Produktionsstandort production site | Material ESWT material spout | Material Verschluss material cap | Ø Austrittsöffnung Ø orifice size | Originalitätsverschluss tamper evidence |
|----------------------------|--|---------------------------------|-------------------------------------|--------------------------------------|--|
| WELDSPOUT // WELDPOUT | | | | | |
| 611915991 | US | PE | - | 34 mm | - |
| VERSCHLUSS // CAP | | | | | |
| 611113001 | US | - | PP | - | ■ |

FÜLLUNG DURCH DEN BEUTEL UND DEN WELDSPOUT // FILLING THROUGH POUCH AND WELDPOUT

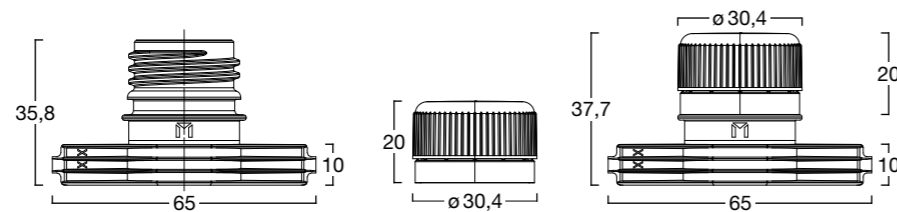

| Artikel-Nr. article no. | Produktionsstandort production site | Material ESWT material spout | Material Verschluss material cap | Ø Austrittsöffnung Ø orifice size | Originalitätsverschluss tamper evidence |
|---|--|---------------------------------|-------------------------------------|--------------------------------------|--|
| WELDSPOUT // WELDPOUT | | | | | |
| 12546..7 | DE | PE | - | 21,5 mm | - |
| VERSCHLUSS // CAP | | | | | |
| 12820..1 | DE | - | PE | - | ■ |
| 13101..1 | DE | - | PE | - | - |
| WELDSPOUT MIT VERSCHLUSS // WELDPOUT WITH CAP | | | | | |
| 38576..1 | DE | PE | PE | 21,5 mm | ■ |

FÜLLUNG DURCH DEN BEUTEL UND DEN WELDSPOUT // FILLING THROUGH POUCH AND WELDPOUT

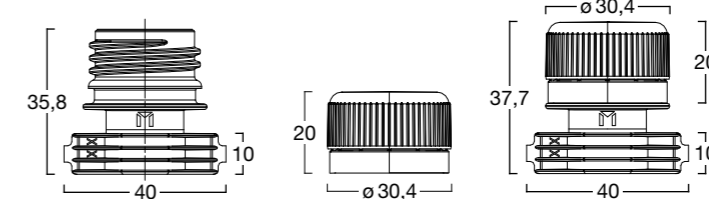

| Artikel-Nr. article no. | Produktionsstandort production site | Material ESWT material spout | Material Verschluss material cap | Ø Austrittsöffnung Ø orifice size | Originalitätsverschluss tamper evidence |
|---|--|---------------------------------|-------------------------------------|--------------------------------------|--|
| WELDSPOUT // WELDPOUT | | | | | |
| 12839..1 | DE | PE | - | 21,5 mm | - |
| VERSCHLUSS // CAP | | | | | |
| 12820..1 | DE | - | PE | - | ■ |
| 13101..1 | DE | - | PE | - | - |
| WELDSPOUT MIT VERSCHLUSS // WELDPOUT WITH CAP | | | | | |
| 38577..1 | DE | PE | PE | 21,5 mm | ■ |

FÜLLUNG DURCH DEN BEUTEL UND DEN WELDSPOUT // FILLING THROUGH POUCH AND WELDPOUT

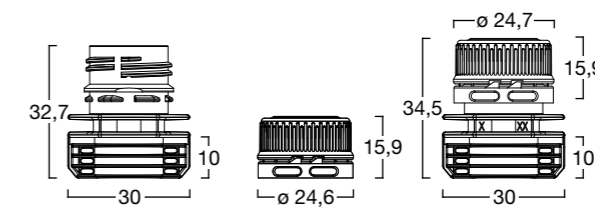

| Artikel-Nr. article no. | Produktionsstandort production site | Material ESWT material spout | Material Verschluss material cap | Ø Austrittsöffnung Ø orifice size | Originalitätsverschluss tamper evidence |
|---|--|---------------------------------|-------------------------------------|--------------------------------------|--|
| WELDSPOUT // WELDPOUT | | | | | |
| 13065..1 | CN | PE | - | 17,2 mm | - |
| VERSCHLUSS // CAP | | | | | |
| 13066..1 | CN | - | PP | - | ■ |
| WELDSPOUT MIT VERSCHLUSS // WELDPOUT WITH CAP | | | | | |
| 38571..1 | CN | PE | PP | 17,2 mm | ■ |

Die höchsten Qualitätsstandards.

Zu jeder Zeit. Überall.

The highest quality standards.

Anytime. Anywhere.

▼
MENSHEN – SUSTAINABLE INNOVATIVE PACKAGING.





3

Chemieverschlüsse *Chemical closures*

In der chemischen Industrie hat Sicherheit Priorität. Deshalb setzen wir bei MENSHEN, als Vollsortimenter und führender Anbieter im Bereich der Chemieverschlüsse, auf die umfassenden Branchenkenntnisse und Kompetenzen unserer Mitarbeiter*innen. Unser Anspruch: Chemieverschlüsse von MENSHEN müssen selbst bei Großserien alle Qualitäts- und Sicherheitsstandards bestens erfüllen. Dank ausgereifter Fertigungsprozesse und einer permanenten Qualitätssicherung sowie Fertigungsüberwachung können wir größte Zuverlässigkeit bei unseren Produkten garantieren.

Wir wissen: Jeder Anwendungsbereich hat individuelle Anforderungen. Deshalb können Sie je nach Einsatzgebiet aus verschiedenen Produkteigenschaften und Zusatzfunktionen wählen. Gerne beraten wir Sie über die wichtigsten Eigenschaften und entwickeln bei Bedarf Sonderlösungen, die Ihren Vorstellungen vollständig entsprechen.

Safety is of the utmost importance in the chemicals industry. Therefore, at MENSHEN, we rely on the extensive industry knowledge and expertise of our employees as a full-line supplier and leading provider of chemical closures. Our mission: MENSHEN chemical closures must optimally fulfill all quality and safety standards, even in large-batch production. Thanks to sophisticated manufacturing processes, constant quality assurance, and production monitoring, we can guarantee the highest level of reliability in our products.

We know that each application has its own individual requirements. As a result, you can choose from various product characteristics and additional functions depending on the area of application. We would be happy to discuss the main characteristics with you, and we also develop special solutions on request that fully meet your requirements.

ORIGINALITÄTSVERSCHLÜSSE // TAMPER-EVIDENT CLOSURES

Die Originalitätsverschlüsse von MENSHEN signalisieren Konsumenten*innen das erstmalige Öffnen des Deckels. Besonders für die chemische und pharmazeutische Industrie stellt dieser Verschluss einen unverzichtbaren Sicherheitsfaktor dar. MENSHEN bietet für jede Anforderung die passende Lösung. Als Kunde haben Sie deshalb die Wahl zwischen verschiedenen Originalitätsverschlüssen mit innenliegendem, konturbündigem oder außenstehendem Ring.

MENSHEN tamper-evident closures signal when they have been undone for the first time and are especially designed for consumer protection purposes. This type of closure is an indispensable safety factor for the chemical and pharmaceutical industries. Whether with an internal tamper-evident ring, being flush to the cap diameter, or with an external ring – there is always a suitable solution for every requirement.

ENTGASUNGSVERSCHLÜSSE // CLOSURES WITH VENTING DEVICE

Die Entgasungsverschlüsse von MENSHEN ermöglichen den gesteuerten und dadurch sicheren Austritt von entstandenen Gasen der Füllgüter. Der Druck im Behälter wird konstant gehalten. Gleichzeitig verhindern Entgasungsverschlüsse selbstverständlich auch das Austreten von Flüssigkeiten, und das in bewährter Qualität. Durch jahrelange Forschung und die enge Zusammenarbeit mit unseren Kunden sind MENSHEN Produkte so optimiert, dass wir höchste Sicherheit garantieren können.

Many years of research, planning and cooperation with our customers have made it possible to optimise our products, enabling us to guarantee a high degree of safety. Our closures with venting devices allow the controlled escape of gases produced by the product and thus keep the pressure in the container at a constant level. At the same time, they prevent the liquids from leaking with proven MENSHEN tightness.

KINDERGESICHERTE VERSCHLÜSSE // CHILD RESISTANT CLOSURES

Besonders Chemikalienbehälter müssen im Haushalt hohe Sicherheitsstandards erfüllen, um keine Gefahr darzustellen. Die kindergesicherten Verschlüsse von MENSHEN verfügen über eine Mechanik, die optimal vor unerwünschtem Öffnen schützt. Für Erwachsene stellt die spezielle Sicherung trotzdem kein Hindernis dar. Übrigens: Alle MENSHEN Produkte erfüllen die internationalen Normen für kindergesicherte Verpackungen.

We are all aware of the high safety factor which chemical containers require in the household. Child-resistant closures are fitted with a mechanism which cannot be opened by children. The special safety lock always reliably prevents children from opening them and nevertheless does not pose an obstacle for the elderly. All MENSHEN products meet the international standards for child-resistant packaging – safety is our strength.

ABDICHTUNGSVARIANTEN // SEAL VARIANTS

Besonders bei Chemieverschlüssen ist die absolute Dichtigkeit ein wichtiger Punkt, der Sicherheit gewährleistet. Die Verschlusslösungen von MENSHEN verfügen über unterschiedliche Dichteinlagen, die ein ungewolltes Austreten von Flüssigkeiten oder Gasen verhindern.

Absolute seal tightness is particularly important in the case of chemical closures in order to ensure a high level of safety. MENSHEN closure solutions have a range of seal liners that prevent the unintended leakage of liquids or gases.

- PTFE-Einlage
- PE-Schaumeinlage
- Konusausführung
- PTFE-kaschierte PE-Schaumeinlage
- Induktionseinlage
- Aluminiumbeschichtete Einlage verhindert das Migrieren in die Chemie
- PTFE liner
- PE foam liner
- Cone version
- PTFE/PE foam liner
- Induction liner
- Aluminum-coated liner prevents seeping into chemicals

CHEMIEVERSCHLÜSSE // CHEMICAL CLOSURES

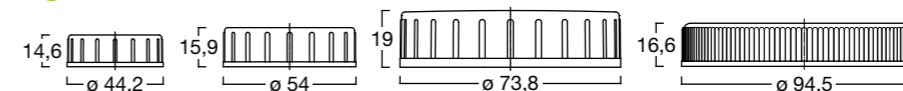

| Artikel-Nr. article no. | Material material | Anbringungsart fixing type | Gewindegröße thread size | Dichtung seal | Originalitätsverschluss tamper evidence | Kindersicherung child resistance | Entgasung venting device |
|----------------------------|----------------------|---------------------------------|-----------------------------|------------------|--|-------------------------------------|-----------------------------|
| 20658..1 | PE | Schraubversion screw version | 40 mm | Einlage liner | - | - | - |
| 20087..1 | PE | Schraubversion screw version | 50 mm | Einlage liner | - | - | - |
| 20056..1 | PE | Schraubversion screw version | 70 mm | Einlage liner | - | - | - |
| 20715..1 | PE | Schraubversion screw version | 90 mm | Einlage liner | - | - | - |

CHEMIEVERSCHLÜSSE // CHEMICAL CLOSURES

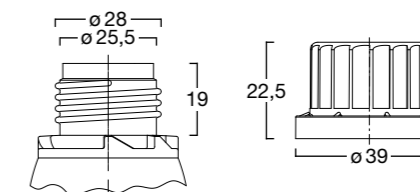

| Artikel-Nr. article no. | Material material | Anbringungsart fixing type | Gewindegröße thread size | Dichtung seal | Originalitätsverschluss tamper evidence | Kindersicherung child resistance | Entgasung venting device |
|----------------------------|----------------------|---------------------------------|-----------------------------|------------------|--|-------------------------------------|-----------------------------|
| 11287..1 | PP | Schraubversion screw version | 28 E | Konus cone | ■ | - | - |
| 21287..2 | PP | Schraubversion screw version | 28 E | Einlage liner | ■ | - | - |

CHEMIEVERSCHLÜSSE // CHEMICAL CLOSURES

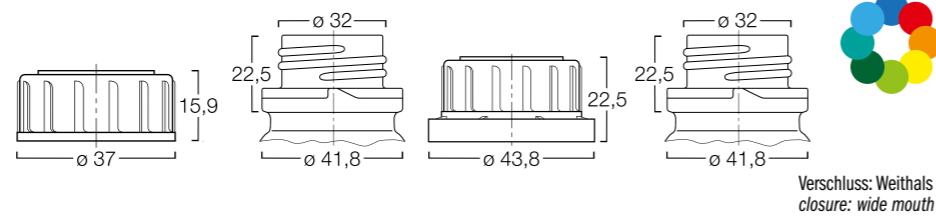

Verschluss: Weithals
closure: wide mouth

| Artikel-Nr. article no. | Material material | Anbringungsart fixing type | Gewindegröße thread size | Dichtung seal | Originalitätsverschluss tamper evidence | Kindersicherung child resistance | Entgasung venting device |
|----------------------------|----------------------|---------------------------------|-----------------------------|------------------|--|-------------------------------------|-----------------------------|
| 10678..1 | PP | Schraubversion screw version | 32 W | Konus cone | ■ | - | - |
| 10678..2 | PP | Schraubversion screw version | 32 W | Konus cone | - | - | - |
| 20843..1 | PP | Schraubversion screw version | 32 W | Einlage liner | ■ | - | - |
| 20843..2 | PP | Schraubversion screw version | 32 W | Einlage liner | - | - | - |

CHEMIEVERSCHLÜSSE // CHEMICAL CLOSURES

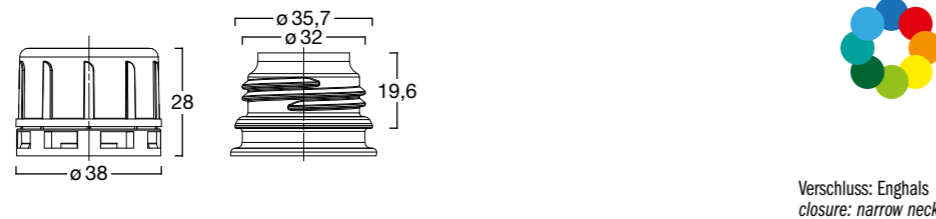

Verschluss: Enghals
closure: narrow neck

| Artikel-Nr. article no. | Material material | Anbringungsart fixing type | Gewindegröße thread size | Dichtung seal | Originalitätsverschluss tamper evidence | Kindersicherung child resistance | Entgasung venting device |
|----------------------------|----------------------|---------------------------------|-----------------------------|------------------------------------|--|-------------------------------------|-----------------------------|
| 12544..3 | PP | Schraubversion screw version | 32 E | Konus cone | ■ | - | - |
| 22544..1 | PP | Schraubversion screw version | 32 E | PTFE-Napf PTFE disc | ■ | - | - |
| 22544..2 | PP | Schraubversion screw version | 32 E | Einlage liner | ■ | - | - |
| 22544..5 | PP | Schraubversion screw version | 32 E | Entgasungseinlage venting liner | ■ | - | ■ |

CHEMIEVERSCHLÜSSE // CHEMICAL CLOSURES

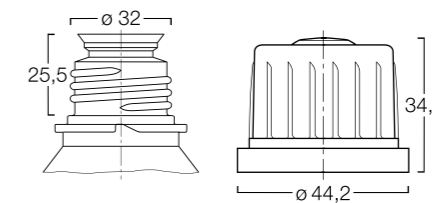

Verschluss: Enghals
closure: narrow neck



| Artikel-Nr. article no. | Material material | Anbringungsart fixing type | Gewindegröße thread size | Dichtung seal | Originalitätsverschluss tamper evidence | Kindersicherung child resistance | Entgasung venting device |
|----------------------------|----------------------|---------------------------------|-----------------------------|---------------------------------------|--|-------------------------------------|-----------------------------|
| 10677..1 | PP | Schraubversion screw version | 32 E | Konus cone | ■ | - | - |
| 20677..1 | PP | Schraubversion screw version | 32 E | Konus + PTFE-Napf cone + PTFE disc | ■ | - | - |
| 20842..1 | PP | Schraubversion screw version | 32 E | Einlage liner | ■ | - | - |
| 20842..2 | PP | Schraubversion screw version | 32 E | Entgasungseinlage venting liner | ■ | - | ■ |

CHEMIEVERSCHLÜSSE // CHEMICAL CLOSURES

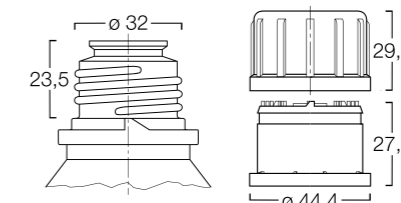

Verschluss: Enghals
closure: narrow neck



| Artikel-Nr. article no. | Material Außenteil material outside part | Material Innenteil material inner part | Anbringungsart fixing type | Gewindegröße thread size | Dichtung seal | Originalitätsverschluss tamper evidence | Kindersicherung child resistance | Entgasung venting device |
|----------------------------|---|---|---------------------------------|-----------------------------|------------------|--|-------------------------------------|-----------------------------|
| 31501..1 | PP | PP | Schraubversion screw version | 32 E | Konus cone | ■ | ■ | - |
| 34501..3 | PP | PP | Schraubversion screw version | 32 E | Konus cone | ■ | ■ | ■ |

CHEMIEVERSCHLÜSSE // CHEMICAL CLOSURES

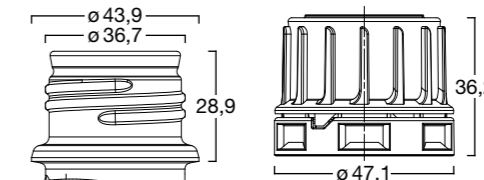

Verschluss: Enghals
closure: narrow neck



| Artikel-Nr. article no. | Material Außenteil material outside part | Material Innenteil material inner part | Anbringungsart fixing type | Gewindegröße thread size | Dichtung seal | Originalitätsverschluss tamper evidence | Kindersicherung child resistance | Entgasung venting device |
|----------------------------|---|---|---------------------------------|-----------------------------|------------------|--|-------------------------------------|-----------------------------|
| 22812..1 | PP | - | Schraubversion screw version | 38 E | Einlage liner | ■ | - | - |

CHEMIEVERSCHLÜSSE // CHEMICAL CLOSURES

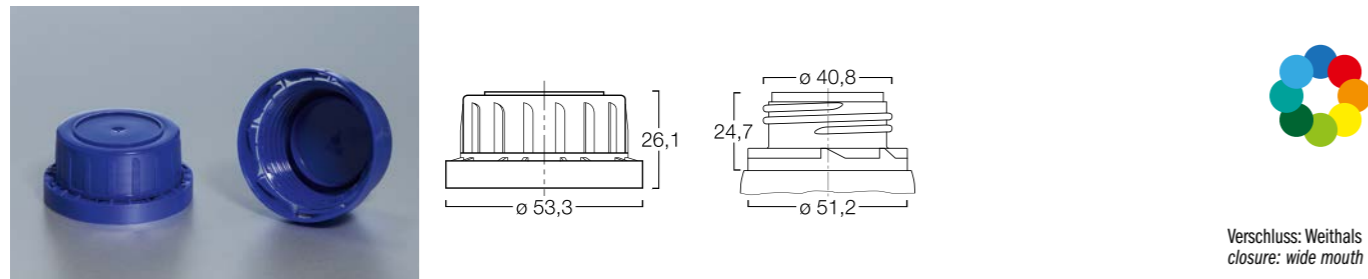

Verschluss: Weithals
closure: wide mouth

| Artikel-Nr. article no. | Material material | Anbringungsart fixing type | Gewindegröße thread size | Dichtung seal | Originalitätsverschluss tamper evidence | Kindersicherung child resistance | Entgasung venting device |
|----------------------------|----------------------|---------------------------------|-----------------------------|------------------|--|-------------------------------------|-----------------------------|
| 10713..1 | PP | Schraubversion screw version | 40 W | Konus cone | ■ | - | - |
| 20804..1 | PP | Schraubversion screw version | 40 W | Einlage liner | ■ | - | - |

CHEMIEVERSCHLÜSSE // CHEMICAL CLOSURES

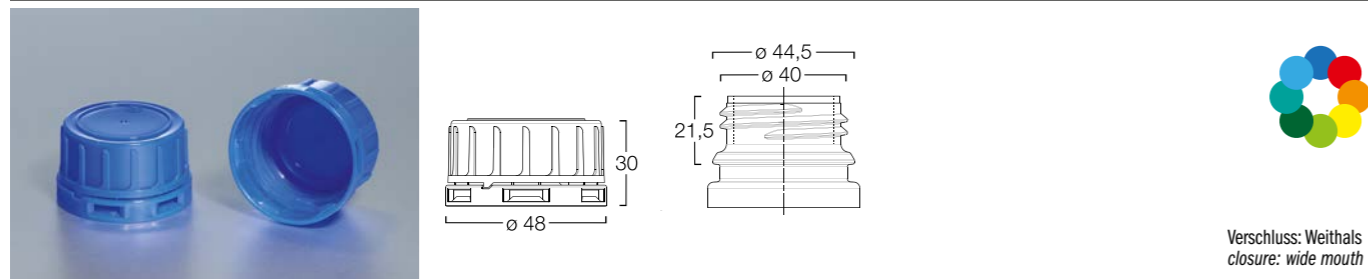

Verschluss: Weithals
closure: wide mouth

| Artikel-Nr. article no. | Material material | Anbringungsart fixing type | Gewindegröße thread size | Dichtung seal | Originalitätsverschluss tamper evidence | Kindersicherung child resistance | Entgasung venting device |
|----------------------------|----------------------|---------------------------------|-----------------------------|------------------|--|-------------------------------------|-----------------------------|
| 12745..1 | PP | Schraubversion screw version | 40 W | Konus cone | ■ | - | - |
| 22745..1 | PP | Schraubversion screw version | 40 W | Einlage liner | ■ | - | - |

CHEMIEVERSCHLÜSSE // CHEMICAL CLOSURES

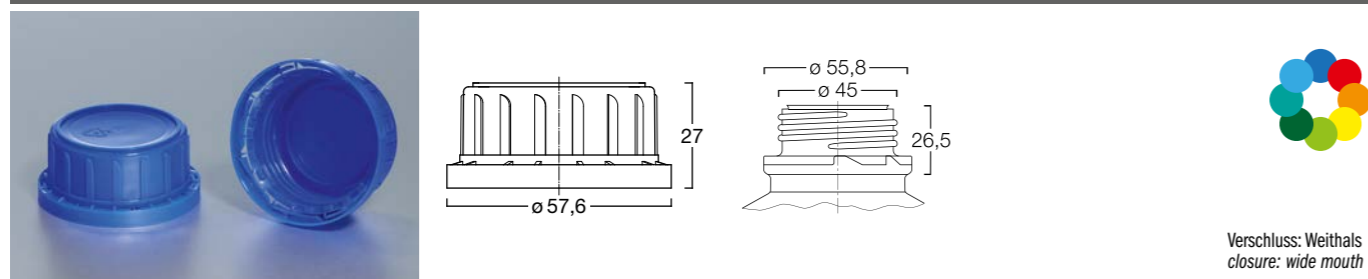

Verschluss: Weithals
closure: wide mouth

| Artikel-Nr. article no. | Material material | Anbringungsart fixing type | Gewindegröße thread size | Dichtung seal | Originalitätsverschluss tamper evidence | Kindersicherung child resistance | Entgasung venting device |
|----------------------------|----------------------|---------------------------------|-----------------------------|------------------|--|-------------------------------------|-----------------------------|
| 11663..1 | PP | Schraubversion screw version | 45 W | Konus cone | ■ | - | - |
| 20709..1 | PP | Schraubversion screw version | 45 W | Einlage liner | ■ | - | - |
| 20709..2 | PP | Schraubversion screw version | 45 W | Einlage liner | - | - | - |

CHEMIEVERSCHLÜSSE // CHEMICAL CLOSURES

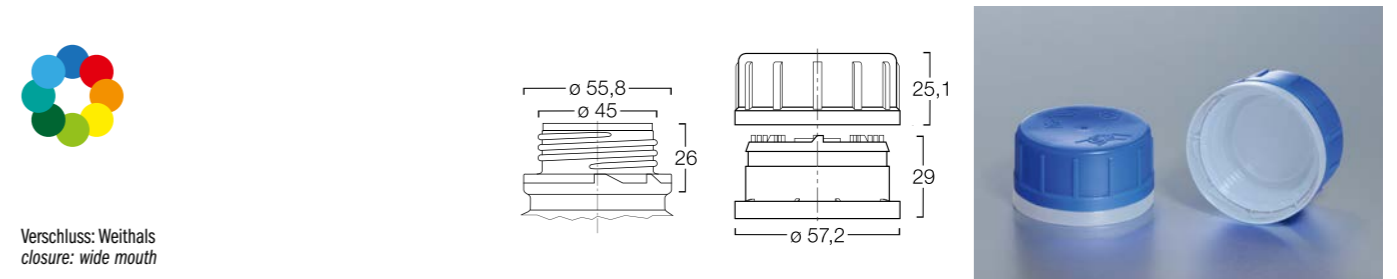

Verschluss: Weithals
closure: wide mouth

| Artikel-Nr. article no. | Material Außenteil material outside part | Material Innenteil material inner part | Anbringungsart fixing type | Gewindegröße thread size | Dichtung seal | Originalitätsverschluss tamper evidence | Kindersicherung child resistance | Entgasung venting device |
|----------------------------|---|---|---------------------------------|-----------------------------|------------------|--|-------------------------------------|-----------------------------|
| 31504..1 | PP | PP | Schraubversion screw version | 45 W | Konus cone | ■ | ■ | - |
| 34502..3 | PP | PP | Schraubversion screw version | 45 W | Konus cone | ■ | ■ | ■ |

CHEMIEVERSCHLÜSSE // CHEMICAL CLOSURES

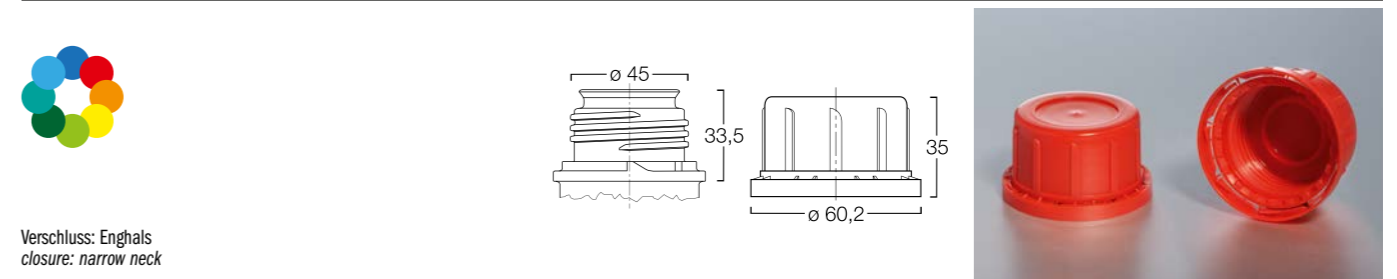

Verschluss: Enghals
closure: narrow neck

| Artikel-Nr. article no. | Material material | Anbringungsart fixing type | Gewindegröße thread size | Dichtung seal | Originalitätsverschluss tamper evidence | Kindersicherung child resistance | Entgasung venting device |
|----------------------------|----------------------|---------------------------------|-----------------------------|---------------------------------------|--|-------------------------------------|-----------------------------|
| 11337..1 | PP | Schraubversion screw version | 45 E | Konus cone | ■ | - | - |
| 21337..1 | PP | Schraubversion screw version | 45 E | Konus + PTFE-Napf cone + PTFE disc | ■ | - | - |
| 20671..1 | PP | Schraubversion screw version | 45 E | Einlage liner | ■ | - | - |
| 20671..2 | PP | Schraubversion screw version | 45 E | Entgasungseinlage venting liner | ■ | - | ■ |

CHEMIEVERSCHLÜSSE // CHEMICAL CLOSURES

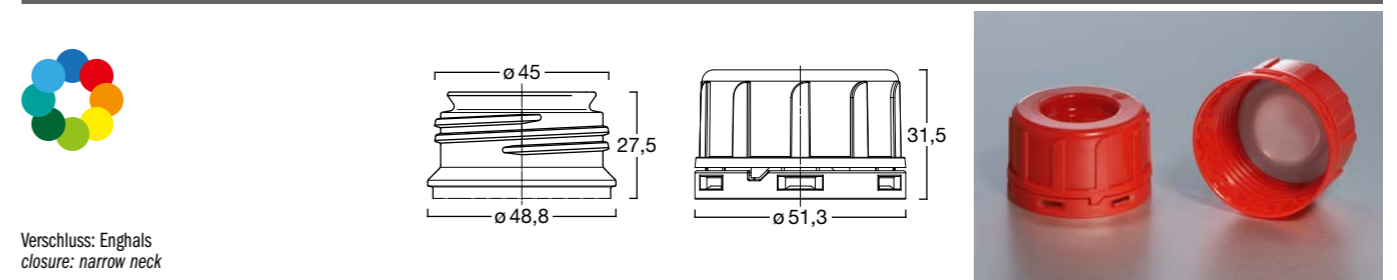

Verschluss: Enghals
closure: narrow neck

| Artikel-Nr. article no. | Material material | Anbringungsart fixing type | Gewindegröße thread size | Dichtung seal | Originalitätsverschluss tamper evidence | Kindersicherung child resistance | Entgasung venting device |
|----------------------------|----------------------|---------------------------------|-----------------------------|---------------------------------------|--|-------------------------------------|-----------------------------|
| 12817..1 | PE | Schraubversion screw version | 45 E | Konus cone | ■ | - | - |
| 22817..1 | PE | Schraubversion screw version | 45 E | Konus + PTFE-Napf cone + PTFE disc | ■ | - | - |

CHEMIEVERSCHLÜSSE // CHEMICAL CLOSURES

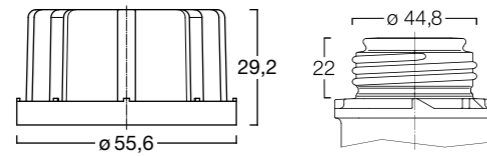

Verschluss: Enghals
closure: narrow neck

| Artikel-Nr. article no. | Material material | Anbringungsart fixing type | Gewindegröße thread size | Dichtung seal | Originalitätsverschluss tamper evidence | Kindersicherung child resistance | Entgasung venting device |
|----------------------------|----------------------|---------------------------------|-----------------------------|---------------------------------------|--|-------------------------------------|-----------------------------|
| 11864..1 | PP | Schraubversion screw version | 45 E | Konus cone | ■ | - | - |
| 21864..1 | PP | Schraubversion screw version | 45 E | Konus + PTFE-Napf cone + PTFE disc | ■ | - | - |

CHEMIEVERSCHLÜSSE // CHEMICAL CLOSURES

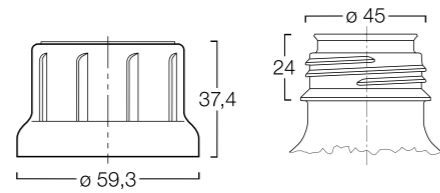

Verschluss: Enghals
closure: narrow neck

| Artikel-Nr. article no. | Material Verschluss material closure | Material Ring material ring | Anbringungsart fixing type | Gewindegröße thread size | Dichtung seal | Originalitätsverschluss tamper evidence | Kindersicherung child resistance | Entgasung venting device |
|----------------------------|---|--------------------------------|---------------------------------|-----------------------------|--|--|-------------------------------------|-----------------------------|
| 34404..1 | PP | PP | Schraubversion screw version | 45 E | PE-Dichtnapf 817 + PTFE-Napf PE-seal bowl 817 + PTFE disc | ■ | - | ■ |

CHEMIEVERSCHLÜSSE // CHEMICAL CLOSURES

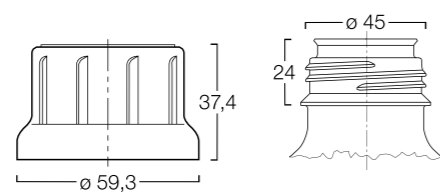

Verschluss: Enghals
closure: narrow neck

| Artikel-Nr. article no. | Material Verschluss material closure | Material Ring material ring | Anbringungsart fixing type | Gewindegröße thread size | Dichtung seal | Originalitätsverschluss tamper evidence | Kindersicherung child resistance | Entgasung venting device |
|----------------------------|---|--------------------------------|---------------------------------|-----------------------------|--|--|-------------------------------------|-----------------------------|
| 31401..3 | PP | PP | Schraubversion screw version | 45 E | PE-Dichtnapf 1284 + PTFE-Napf PE-seal bowl 1284 + PTFE disc | ■ | - | - |
| 31401..2 | PP | PP | Schraubversion screw version | 45 E | Einlage liner | ■ | - | - |

CHEMIEVERSCHLÜSSE // CHEMICAL CLOSURES

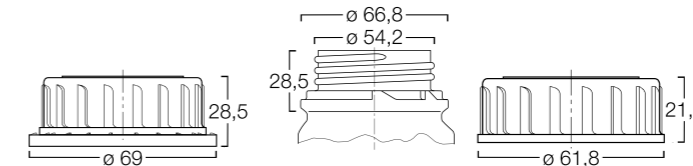

Verschluss: Weithals
closure: wide mouth



| Artikel-Nr. article no. | Material material | Anbringungsart fixing type | Gewindegröße thread size | Dichtung seal | Originalitätsverschluss tamper evidence | Kindersicherung child resistance | Entgasung venting device |
|----------------------------|----------------------|---------------------------------|-----------------------------|------------------|--|-------------------------------------|-----------------------------|
| 10698..1 | PP | Schraubversion screw version | 54 W | Konus cone | - | - | - |
| 10968..1 | PP | Schraubversion screw version | 54 W | Konus cone | ■ | - | - |

CHEMIEVERSCHLÜSSE // CHEMICAL CLOSURES

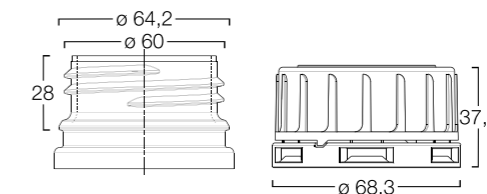

Verschluss: Weithals
closure: wide mouth



| Artikel-Nr. article no. | Material material | Anbringungsart fixing type | Gewindegröße thread size | Dichtung seal | Originalitätsverschluss tamper evidence | Kindersicherung child resistance | Entgasung venting device |
|----------------------------|----------------------|---------------------------------|-----------------------------|------------------|--|-------------------------------------|-----------------------------|
| 12746..1 | PP | Schraubversion screw version | 60 W | Konus cone | ■ | - | - |
| 22746..1 | PP | Schraubversion screw version | 60 W | Einlage liner | ■ | - | - |

CHEMIEVERSCHLÜSSE // CHEMICAL CLOSURES

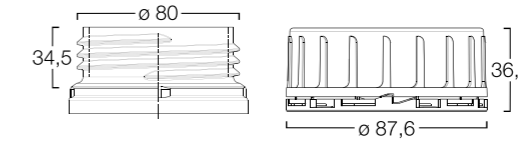

Verschluss: Weithals
closure: wide mouth



| Artikel-Nr. article no. | Material material | Anbringungsart fixing type | Gewindegröße thread size | Dichtung seal | Originalitätsverschluss tamper evidence | Kindersicherung child resistance | Entgasung venting device |
|----------------------------|----------------------|---------------------------------|-----------------------------|------------------|--|-------------------------------------|-----------------------------|
| 12747..1 | PP | Schraubversion screw version | 80 W | Konus cone | ■ | - | - |
| 22747..1 | PP | Schraubversion screw version | 80 W | Einlage liner | ■ | - | - |



CHEMIEVERSCHLÜSSE // CHEMICAL CLOSURES

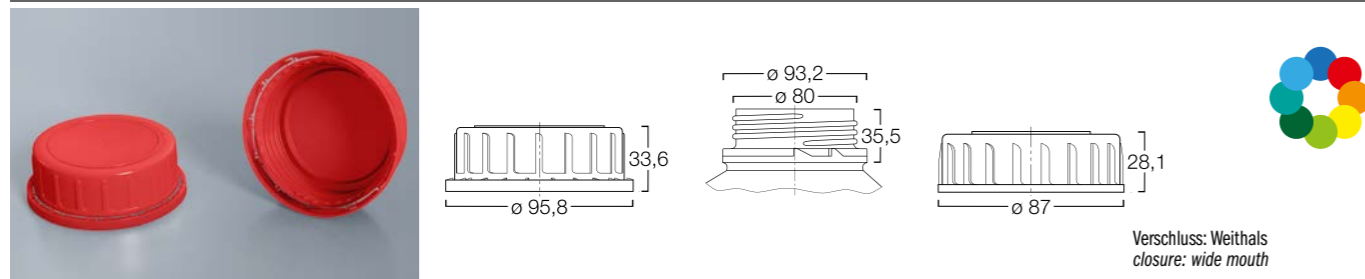

| Artikel-Nr. article no. | Material material | Anbringungsart fixing type | Gewindegröße thread size | Dichtung seal | Originalitätsverschluss tamper evidence | Kindersicherung child resistance | Entgasung venting device |
|----------------------------|----------------------|---------------------------------|-----------------------------|------------------|--|-------------------------------------|-----------------------------|
| 11524..1 | PP | Schraubversion screw version | 80 W | Konus cone | - | - | - |
| 11206..1 | PP | Schraubversion screw version | 80 W | Konus cone | ■ | - | - |
| 21523..1 | PP | Schraubversion screw version | 80 W | Einlage liner | - | - | - |
| 20639..1 | PP | Schraubversion screw version | 80 W | Einlage liner | ■ | - | - |

STAUBSCHUTZ-KAPPEN // PROTECTION PLUGS

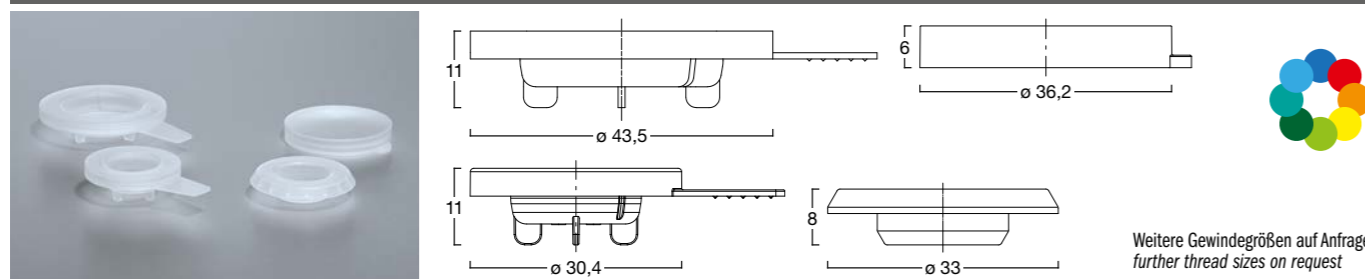

| Artikel-Nr. article no. | Material material | Anbringungsart fixing type | Mündungsgröße orifice size | Dichtung seal | Originalitätsverschluss tamper evidence | Kindersicherung child resistance | Entgasung venting device |
|----------------------------|----------------------|---------------------------------|-------------------------------|------------------|--|-------------------------------------|-----------------------------|
| 12635..1 | PE | Prellversion push on version | DIN 32 | - | - | - | - |
| 10456..2 | PE | Prellversion push on version | 38 mm | - | - | - | - |
| 11229..1 | PE | Prellversion push on version | DIN 45 | - | - | - | - |
| 11177..1 | PE | Prellversion push on version | DIN 32 | - | - | - | - |

ÖFFNUNGSHILFEN FÜR SCHRAUBVERSCHLÜSSE // ACCESSORIES FOR SCREW CAPS

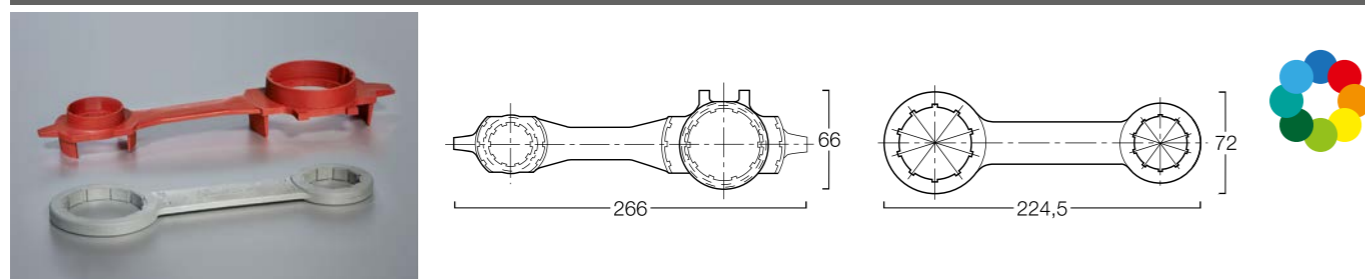

| Artikel-Nr. article no. | Schlüssel für key for | Artikel-Nr. article no. | Schlüssel für key for |
|----------------------------|--------------------------|----------------------------|--------------------------|
| 10166..1 | DIN 32 / 45 | 10246..1 | DIN 32 / 45 / 54 / 80 |

1 Originalitätssicherung
Tamper-evidence

Die Originalitätssicherung kann nur durch die entsprechende Gestaltung der Behältermündung erfüllt werden.

It should be noted that the protection function of the tamper-evident closure can only be fulfilled if the container neck is correspondingly designed.

2 Kindersicherung
Child resistance

Die Kindersicherung bezieht sich auf die Gesamtverpackung, bestehend aus Verschluss und Behältnis. Eine Prüfung sowie die Ausstellung eines entsprechenden Zertifikats ist notwendig.

It should be noted that the protection function of the child resistant device relates only to the complete packaging unit comprising closure and container, subsequent to testing and issue of a relevant certificate.

3 Be- oder Entgasung
Degassing/Venting

Die Funktion der Be- oder Entgasung wird nur bei sachgerechter Lagerung und bei sachgerechtem Transport der Gesamtverpackung erfüllt. Zwischen Entgasungsmembrane und Füllgut ist ein Luftraum notwendig.

It should be noted that the venting function can only be fulfilled by proper storage and transportation of the complete packaging unit. Allowance made for an air space between the venting membrane and the product.

4 Füllgutverträglichkeit
Compatibility of the filling contents

Eine Füllgutverträglichkeit mit unseren Produkten können wir nicht garantieren.

We cannot guarantee the compatibility of the filling contents and our products.

Kompatible Kapseln für Kaffee – und lösliche Getränke.
Perfekte Abstimmung mit dem Kunden von der Röstung
des Kaffees bis hin zur fertigen Kapsel.

Single serve coffee, Solubles, Other hot drinks.
Perfect adjustment with customers started from the
coffee roasting till production of the final cap.



KAPSEL-LÖSUNGEN // CAPSULE SOLUTIONS

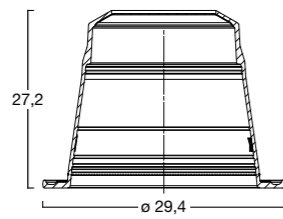

BARISTA Capsule 2.0

- High barrier
- Patented grid
- Compatible with all machines in the market

| Artikel-Nr. article no. | Produktionsstandort production site | Material material | Füllvolumen filling volume | Dichtung sealing | Sonstiges others |
|----------------------------|--|----------------------|-------------------------------|---|---------------------|
| 22980..1 | DE | PP/EVOH/PP | 13,2 ml | Patented sealing area - diamond grid | |
| 57010 | ES | PP/EVOH/PP | 13,2 ml | Patented sealing area - diamond grid | |

KAPSEL-LÖSUNGEN // CAPSULE SOLUTIONS

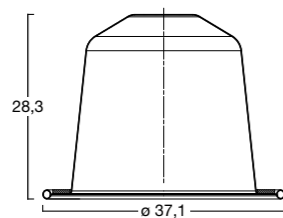

BARISTA Capsule Alu 1.0

- High barrier
- Recyclable ready

| Artikel-Nr. article no. | Produktionsstandort production site | Material material | Füllvolumen filling volume | Sonstiges others |
|----------------------------|--|----------------------|-------------------------------|--------------------------|
| 77002 | ES | PP/EVOH/PP | 13,25 ml | Für Kaffee for coffee |

KAPSEL-LÖSUNGEN // CAPSULE SOLUTIONS

BARISTA Capsule Alu 2.0

- High barrier
- Recyclable ready

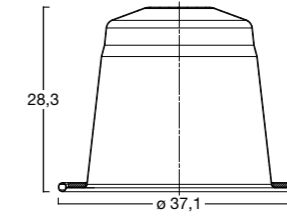

| Artikel-Nr. article no. | Produktionsstandort production site | Material material | Füllvolumen filling volume | Sonstiges others |
|----------------------------|--|----------------------|-------------------------------|--------------------------|
| 77000 | ES | PP/EVOH/PP | 13,25 ml | Für Kaffee for coffee |

KAPSEL-LÖSUNGEN // CAPSULE SOLUTIONS

MATRYOSHKA Capsule 1.0

- No barrier
- Recyclable ready
- Suitable for coffee,
solubles, tea, etc.

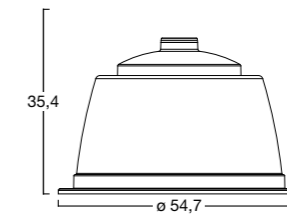

| Artikel-Nr. article no. | Produktionsstandort production site | Material material | Sonstiges others |
|----------------------------|--|----------------------|---------------------------------------|
| 57003/05 | ES | PP/EVOH/PP | Für Kaffee for coffee |
| 57003/XX | ES | PP/EVOH/PP | Für lösliche Getränke for solubles |

KAPSEL-LÖSUNGEN // CAPSULE SOLUTIONS

MATRYOSHKA Capsule 2.0

- High barrier
- Recyclable ready
- Suitable for coffee,
solubles, tea, etc.

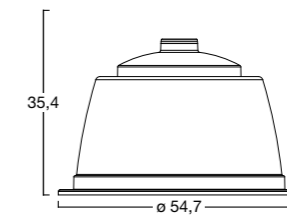

| Artikel-Nr. article no. | Produktionsstandort production site | Material material | Sonstiges others |
|----------------------------|--|----------------------|---------------------------------------|
| 39120..1 | DE | PP/EVOH/PP | Für Kaffee for coffee |
| 39119..1 | DE | PP/EVOH/PP | Für lösliche Getränke for solubles |
| 57007/01 | ES | PP/EVOH/PP | Für Kaffee for coffee |
| 57007/xx | ES | PP/EVOH/PP | Für lösliche Getränke for solubles |

Für weitere Informationen fragen Sie bitte
Ihre*n Ansprechpartner*in.

For further information please apply to
your contact.



Erstmals bietet MENSHEN eine Produktlinie speziell für die Kosmetik-Industrie an. Eine große Auswahl an ansprechenden und eleganten Tiegeln, Dispensern und Flaschen für Tönungen, Lotionen und Cremes erweitern unsere Produkt-Range und überzeugen durch ein attraktives Preis-Leistungsverhältnis.

MENSHEN has launched its first generation of packs focused on cosmetics. This elegant packaging concepts offers various style of a high-end cosmetics range from toner and lotion to cream etc. It offers minimalistic elegance, an attractive price/performance ration and excellent production compatibility.

MENSHEN Amerika MENSHEN America

Mexiko // Mexico
MENSHEN Mexicana, S. de C.V. de R. L.
Parque Industrial Exportec
Circuito Ernesto Monroy Cárdenas, 109
Municipio de Toluca, Estado de México
Fon +52 722 2734782
Fax +52 722 2734783
contact@menshenmex.com

USA // United States
MENSHEN Packaging USA, Inc.
21 Industrial Park
Waldwick, NJ 07 463 · United States
Fon +1 201 4457436
Fax +1 201 4453473
info@menshenusa.com

MENSHEN Asien MENSHEN Asia

China // China
MENSHEN Packaging (Shanghai) Co., Ltd.
No. 885, Minyi Rd. · Xin Qiao Industrial Zone
Songjiang District
Shanghai, China, 201612
Fon +86 21 67686000
Fax +86 21 37842798
contact.china@menshen.com.cn

China // China
MENSHEN Packaging
(Guangzhou) Co., Ltd.
No. 63, Xinyan East Rd
Luogang District
Guangzhou, China, 510663
Fon +86 20 32082000
Fax +86 20 32083343
contact.china@menshen.com.cn

Singapur // Singapore
MENSHEN Packaging
Singapore Pte Ltd
3 Gambas Crescent
#08-11 Nordcom I
Singapore 757088
Fon & Fax +65 6686 2026
Mobile +65 9146 2621
contact@menshen.com.sg

MENSHEN Europa MENSHEN Europe

Deutschland // Germany
Georg MENSHEN GmbH & Co. KG
Industriestraße 26
57413 Finnentrop · Germany
Fon +49 2721 518-0
Fax +49 2721 518-198
contact@menshen.com

Deutschland // Germany
Georg MENSHEN GmbH & Co. KG
Selbecke 11
59846 Sundern-Hagen · Germany
Fon +49 2721 518-0
Fax +49 2721 518-198
contact@menshen.com

Deutschland // Germany
Georg MENSHEN GmbH & Co. KG
Im Kahley 1
58840 Plettenberg-Kahley · Germany
Fon +49 2721 518-0
Fax +49 2721 518-198
contact@menshen.com

Frankreich // France
MENSHEN Emballage
France S.A.R.L.
230 Avenue du Grain d'Or
F-41350 Vineuil
Fon +33 672 488 521
adv@menshen.com

Russland // Russia
MENSHEN Packaging CIS, LLC
Kasimovskoye Chaussee 36
Egorievsk, 140304 · Russia
Fon +7 49640 40202
Fax +7 49640 42323
info@menshen.ru

Schweiz // Switzerland
MENSHEN Schweiz GmbH
Ringstrasse 37
6010 Kriens · Switzerland
Fon +41 41 8338866
Fax +41 41 8338869
contact@menshen.ch

Spanien // Spain
MENSHEN Iber S.L.
Polígono Industrial El Pla
Avda. Barcelona, 235
08750 Molins de Rei/ Barcelona · Spain
Fon +34 93 6803065
Fax +34 93 6802501
comercial@menshen.es

Ungarn // Hungary
MENSHEN Hungary/Mikropakk
Jászberényi út 82
1106 Budapest
Fon +36 1 2605521
Fax +36 1 2609340
mikropakk@mikropakk.hu

Vereinigtes Königreich // United Kingdom
MENSHEN Packaging UK Ltd.
92, Portmanmoor Road Industrial Estate
Cardiff CF24 5HB · United Kingdom
Fon +44 2920 473147
Fax +44 2920 473148
sales@menshen.co.uk



MENSHEN Schweiz GmbH
Ringstrasse 37
CH-6010 Kriens

Fon +4141 833 88 66
contact@menshen.swiss
www.menshen.swiss

